

LOOX T Series



We make sure

FUJITSU COMPUTERS
SIEMENS

Are there...

... any technical problems or other questions that you need help with?

Please contact:

- our Hotline/Help Desk (see the enclosed Help Desk List or the Internet: ["www.fujitsu-siemens.com/helpdesk"](http://www.fujitsu-siemens.com/helpdesk))
- Your sales partner
- Your sales office

Additional information is contained in the Help Desk list and the "Warranty" manual.

Latest information on our products, tips, updates etc. can be found on our website at: ["www.fujitsu-siemens.com"](http://www.fujitsu-siemens.com)

This manual was produced by Xerox Global Services

Published by Fujitsu Siemens Computer GmbH

Edition 3

June 2007

Order no.: A26391-K182-Z120-1-7619

LOOX T Series

EasyGuide

Your Pocket LOOX...	1
Important notes	3
Equipment overview	4
Getting started	17
Making telephone calls with the Pocket PC	28
Operating the Pocket PC	39
Creating messages	53
Using the Internet	60
Using GPS functions	61
Using the camera (optional)	62
Working with data	65
Security functions	67
Connecting and networking the Pocket PC with other devices	70
Energy saving functions	72
Troubleshooting and tips	76
Technical data	80
Manufacturer's notes	82
Index	87

Adobe and Acrobat are trademarks of Adobe systems Incorporated and may be protected in certain countries.

Intel is a registered trademark, XScale is trademark of Intel Corporation, U.S.A.

Microsoft, Windows and ActiveSync are registered trademarks of the Microsoft Corporation.

Windows Mobile is a trademark of Microsoft Corporation.

The SD Logo is a trademark of Secure Digital.

The Bluetooth trademarks are the property of Bluetooth SIG, Inc., U.S.A. licensed for Fujitsu Siemens Computers GmbH.

All other trademarks referenced are trademarks or registered trademarks of their respective owners, whose protected rights are acknowledged.

Copyright © Fujitsu Siemens Computers GmbH 2007

All rights reserved, including rights of translation, reproduction by printing, copying or similar methods, in part or in whole.

Offenders will be liable for damages.

All rights reserved, including rights created by patent grant or registration of a utility model or design.

Delivery subject to availability. Subject to technical alterations.

Contents

Your Pocket LOOX...	1
Notational conventions	2
Important notes	3
Safety information	3
Using the Pocket PC	3
Equipment overview	4
Indicators (LEDs) and status indicators in the display	5
Indicators (LEDs)	5
Status indicators on the display	6
Using the operating elements	7
Using the keyboard	7
Key combinations (short cuts)	9
Using the pen and display	9
Using the online buttons for telephony	9
Using the 3-way scroll button and the navigation key	10
Using the application buttons and the softkey buttons	12
Using the on-screen keyboard	14
Software overview	15
Accessories	16
Cradle	16
External GPS antenna (optional)	16
Getting started	17
Checking the contents of the package	17
Removing the protective film from the camera and the screen	17
Installing the battery and the (optional) SIM card	18
Connecting the mains adapter and charging the battery	19
Starting up your Pocket PC for the first time	19
Calibrating the screen	19
Entering a PIN (optional)	20
Familiarising yourself with the basic operation of the device	20
Today screen	20
Internet and intranet connections with CONNECTMOBILITY-E2C	20
Starting CONNECTMOBILITY E2C	20
User data dialogue	21
GPRS/UMTS provider selection	21
Data synchronisation	22
Data synchronisation via Exchange Server	22
Data synchronisation with ActiveSync	22
Using the online help	27
Starting the online help independently of an application:	27
Starting the online help from an application	27
Making telephone calls with the Pocket PC	28
Making a call	28
Entering a phone number	28
Selecting a phone number from your contacts	28
Select a phone number from your list of calls	28
Making emergency calls	29
Answering an incoming call	29

Ending a call	29
Displaying missed calls	29
Using voice dialling (Voice Commander)	30
Making a call via Voice Commander	30
Speed dial function	30
Programming the speed dial function	30
Making a call via the speed dial number	30
Using the hands-free function	31
Muting the telephone	31
Holding a call	32
Making a conference call	32
Setting up a conference call	32
Disconnecting all connections from the conference call	32
Disconnecting selected connections	32
Making video phone calls (optional)	33
Answering an incoming video phone call	33
Making a video phone call	33
Further options for video phone calls	34
Managing contacts	35
Copying contact details from the Pocket PC to the SIM card	35
Copying contacts from the SIM card to the Pocket PC	35
Displaying services on the SIM card (network provider specific)	36
SIM security	36
SIM Lock	36
Blocking the SIM card	36
Configuring phone settings	36
Selecting a network	37
Setting up a Voicemail number	37
Setting up the SMS Service Centre	38
Call Forwarding	38
Operating the Pocket PC	39
Using your Pocket PC's profiles	40
Selecting profiles	40
Configuring profiles	41
Switching the Pocket PC on and off	41
Switching the Pocket PC off and on during normal use (Standby mode)	42
Switching off the Pocket PC to save the battery	42
Resetting the Pocket-PC	43
Soft reset (warm start)	43
Cold starting and restoring factory default settings	44
Out and about with the Pocket PC	45
Transporting the Pocket PC	45
In-flight usage	45
Usage while driving	45
Cleaning the Pocket PC	45
Charging the battery	46
Charging the battery directly via the mains adapter	47
Charging the battery via the cradle	48
Charging the battery via a USB port	48
Optimising battery life	48
Inserting and removing an expansion card	49
Inserting an expansion card	49

Removing the expansion card	50
Using the Pocket PC as a USB Host device	51
Configuring device settings	51
Customising menus	52
Fast access to programs via FSC SpeedMenu	52
Creating messages	53
Inbox	53
Displaying the inbox	53
SMS	54
Creating and sending SMS	54
MMS	54
Configuring the MMS application	55
E-mail	56
Setting up e-mail accounts for POP3, SMTP or IMAP4	56
Setting up an e-mail account for the VPN corporate network	57
Setting up sending e-mail via ActiveSync	57
Creating and sending e-mails	57
Downloading e-mails from a server (e-mail pull)	58
Receiving e-mails and other data automatically in real-time (e-mail push)	59
Using the Internet	60
Accessing the Internet with Internet Explorer	60
Calling up Internet Explorer Mobile	60
Using GPS functions	61
FSC GPSLocator	61
Using the camera (optional)	62
2 megapixel autofocus camera	62
Starting the Pictures & Videos application	62
Starting the camera directly	62
Taking pictures	62
Recording a video sequence	63
Configuring the camera and video settings	64
Working with data	65
Windows Media Player	65
Using Java applications	65
Downloading Java applications	65
Starting Java applications	65
Uninstalling Java applications	66
Compressing files with FSC MobileZip	66
Security functions	67
Password protection	67
Device lock (key and display lock)	68
Locking the device	68
Deactivating the device lock	68
FSC KeyLock	68
Activating FSC KeyLock	68
Switching on with lock active	68
FSC SecureLock (optional)	69
Connecting and networking the Pocket PC with other devices	70

Activating and deactivating radio modules	70
Wireless connection via Wireless LAN	70
Wireless communication with Bluetooth	71
Example:	71
Energy saving functions	72
General information on energy management	72
Using energy saving functions	72
configuring Standby mode	72
Switching off backlight	72
Configuring backlight	73
Configuring Keyboard backlight	73
Configuring device behaviour when E-mail push is activated	73
Switching off the sound and setting the volume	74
Wireless connection via Wireless LAN	75
Using Wireless Manager	75
Troubleshooting and tips	76
Installing new software	76
The Pocket PC's time or date are not correct	76
The Pocket PC's display remains dark	76
The display is difficult to read	76
The Pocket PC switches off	77
The Pocket PC does not start after being switched on	77
The Pocket PC does not respond any more	77
The battery discharges too quickly	78
The End button does not respond properly	78
No sound or minimal volume	78
Poor reception via GPS	78
Contact with hotline/help desk	79
Calling up the IMEI number	79
Calling up the UUID	79
Technical data	80
Pocket PC	80
Battery (Li-Ion)	81
Mains adapter	81
Manufacturer's notes	82
Environmental protection	82
Disposal and recycling	82
CE marking	83
Information on exposure/specific absorption rate (SAR)	84
FCC Regulations	85
FCC Warning Statement for WLAN product	85
RF Exposure Information (SAR)	86
Index	87

Your Pocket LOOX...

... is the first integrated Pocket PC from Fujitsu Siemens Computers which combines a GSM/UMTS mobile phone with an innovative and high-performance handheld and a GPS navigation system.

With Bluetooth and wireless LAN you can establish a connection to other devices at the office and away from it without bothersome cables. With your Pocket LOOX, you can access the Internet via UMTS/GSM or a Wireless LAN for example. You can call up both web and WAP pages with *Internet Explorer*. The ergonomic keyboard is perfect for writing and sending e-mails as well as for SMS and MMS messaging. Thanks to the e-mail push function, you no longer need to download incoming e-mails yourself anymore – instead, they are conveniently transferred automatically directly to your Pocket LOOX. Calendars, contacts and tasks are automatically updated.

Depending on equipment level, your Pocket LOOX will have one or two integrated cameras. The VGA camera is used for video telephony via UMTS. With the aid of the 2 megapixel autofocus camera you can take photographs and then view the results on the high-resolution touchscreen. Alternatively, you can also record video sequences.

Microsoft Windows 5.0 Phone Edition also includes the MS Office applications *Microsoft Word*, *Excel* and *PowerPoint*. You can store notes in written form or verbally, as you would do with a dictation device. With *Microsoft Windows 5.0 Phone Edition* your data will be preserved even if the battery is flat.







Install *ActiveSync* on your computer, connect the Pocket LOOX to your computer and you are ready to synchronise your data. In the office you can then effortlessly transfer all your data and newly created documents to your computer.

With the optional USB Host cable you can use your Pocket LOOX as a USB Host device. You can connect different USB devices, such as an external hard disk, to the Pocket PC. Read your favourite book in total comfort away from home on screen or use the MP3 player.

The following documentation contains additional information on your Pocket PC and the operating system:

- the "Getting Started" poster
- the "Safety" and "Warranty" manuals
- the help function on your Pocket PC
- the files on the Microsoft Getting Started CD (e.g. *.TXT, *.PDF)

Notational conventions

	Pay particular attention to text marked with this symbol. Failure to observe this warning may endanger your health, cause the equipment to malfunction or lead to loss of data. The warranty does not cover defects of the equipment caused by failure to follow these instructions.
	indicates important information that is required to use the device properly.
	refers to an action which you must carry out.
	indicates a result
This style	relates to entries which you must make with the keyboard in a program dialog or command line, such as your password (Name123) or a command for starting a program (start netscape.exe)
This style	refers to information displayed by a program on the screen, e.g.: Installation is completed
<i>This style</i>	is for <ul style="list-style-type: none"> • terms and texts in a software user interface, e.g.: ClickSave. • Program names or file names, e.g. <i>Windows XP</i> or <i>netscape.exe</i>.
"This style"	is for <ul style="list-style-type: none"> • cross-references to another section, e.g. "Safety information" • Cross-references to an external source, such as a web address: For further information visit "www.fujitsu-siemens.com" • Names of hard disks, CDs, DVDs and names and titles of other materials, e.g.: "CD Drivers & Utilities" or "Security" manual
	refers to a key on the keyboard, e.g.: 
This style	indicates words and phrases that are emphasised, e.g.: Do not switch off the device

Important notes

This chapter contains safety notes and important information you must observe when using your Pocket PC.

This Pocket PC complies with the relevant safety regulations for IT equipment. If you have questions as to whether you can set up and operate the Pocket PC in the intended environment, please contact your sales point or our hotline/help desk.

Safety information



Observe the safety notes in the "Safety" manual and the following safety notes to prevent injuries, damage to your device or data loss.

- Please follow the instructions relating to environmental conditions in the ["Technical data", Page 80](#) chapter during installation and before operating the device.
- Connect the mains adapter plug to the mains adapter. The mains adapter plug must never be connected to an electrical outlet without the mains adapter.
- The mains adapter must only be connected to an electrical outlet when the Pocket PC or the cradle is connected to the mains adapter.
- Do not use the mains adapter for other devices.
- Please observe the information in the ["Out and about with the Pocket PC", Page 45](#) chapter when travelling or transporting the device.
- After resetting the Pocket PC (i.e. after a cold start or resetting the device to the factory defaults) the phone functions are active. In the process, the WLAN radio component will briefly become active while it is initialised. Please be aware of this if you are in an environment where radio components must not be used (e.g. hospital, aircraft). Bluetooth is not activated after a reset.
- Prolonged use of headphones, especially at very loud volumes, can cause hearing damage.

Using the Pocket PC

Store the Pocket PC in a fully charged state in a dry environment. When storing the device please do not exceed the permissible temperature limits – see ["Technical data", Page 80](#), section ["Pocket PC", Page 80](#). The lower the temperature at which the batteries are stored, the lower the rate of self-discharge.



Avoid leaving your Pocket PC lying in direct sunlight in a car. The temperature could exceed the permissible temperature in such cases.

To protect the battery, battery charging is discontinued at excessively high temperatures.

Please note that batteries discharge themselves over time. Therefore, recharge the battery of your Pocket PC at regular intervals during the storage period.

Protect your Pocket PC against dirt. Dirt or other contamination can cause contact faults on the connections.

Equipment overview

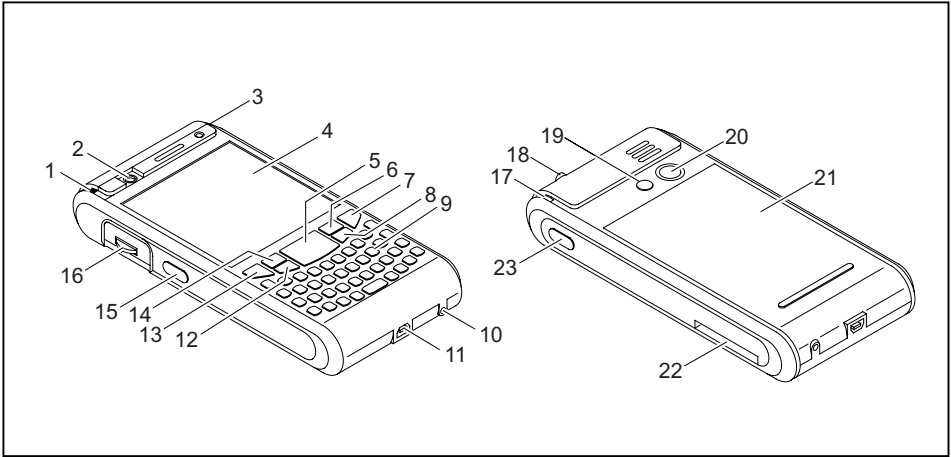

- 1 = Antenna indicator
- 2 = VGA camera
- 3 = Battery/events indicator
- 4 = Display
- 5 = Navigation key
- 6 = Softkey button 2
- 7 = End button
- 8 = Application button 2: Inbox
- 9 = Keyboard with integrated number block
- 10 = GPS antenna port
- 11 = Mini USB port
- 12 = Application button 1: Calendar
- 13 = Answer button
- 14 = Softkey button 1
- 15 = Application button 5: SpeedMenu and camera
- 16 = 3-way scroll button
- 17 = Pen slot
- 18 = Socket for headphones or headset
- 19 = GSM port
- 20 = 2 megapixel autofocus camera
- 21 = Battery compartment
- 22 = Slot for SD/MMC expansion card
- 23 = Application button 6: Voice notes

Indicators (LEDs) and status indicators in the display

Your Pocket-PC has two flashing indicators (LEDs) on the casing which light up in different colours, as well as various status indicators in the title bar of the display which will provide you with information about the current status of your device.

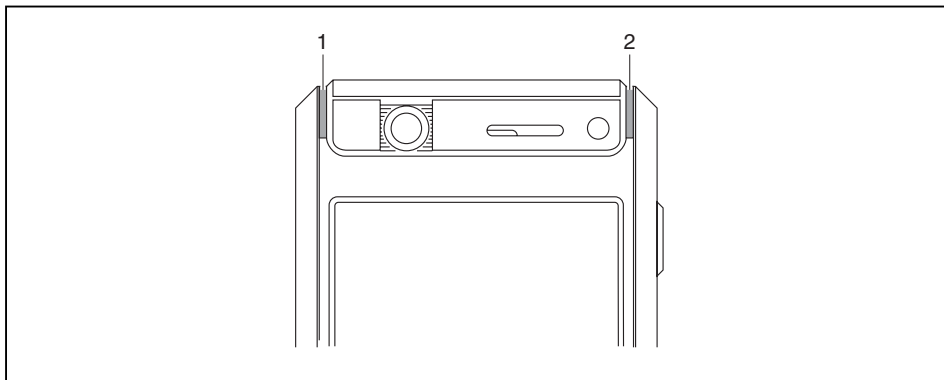

1 = Antenna indicator

2 = Battery/events indicator

Indicators (LEDs)

Indicators	Colour	Indicator state	Meaning
Antenna	Green	Is flashing	GPS has been activated.
	Blue	Is flashing	Bluetooth activated
Battery and events	Orange	On	Battery is fully charged.
		Slow flashing	Battery being charged
	Red	Quick flashing	Battery is overheating
	Blue	Slow flashing	New message available, missed call or schedule reminder active.
	Green	Slow flashing	New e-mail waiting.



























If more than one event occurs at the same time, the coloured LED lights will flash in turn.

For example, if a new e-mail is received while the battery is being charged, the indicator will flash orange and green in turn.

Status indicators on the display

The most important status indicators are shown below:

on-screen display	Meaning	on-screen display	Meaning
	New e-mail, SMS or MMS		No signal
	Incoming telephone call		GPRS available
	Active telephone call		Establishing connection
	Active data connection		UMTS available
	Call forwarding		Roaming
	call is held.		Synchronisation error
	Missed call(s)		Telephone switched off
	Battery indicator, battery full		All system tones switched on
	Battery low		All system tones switched off
	Battery being charged		WLAN active
	Signal strength		WLAN access point available
	Caps Lock activated		Special characters and numbers activated

Using the operating elements

Your Pocket PC offers various operating elements

- Keyboard with integrated number block
- Pen and display
- Online buttons for telephony
- 3-way scroll button
- Navigation key, application buttons and softkey buttons
- On-screen keyboard

Using the keyboard





The keyboard is designed to offer all of the functions of a keyboard with an integrated number block. Some enhanced keyboard functions are accessed via key combinations (short cuts).









Lower case letters are output by default.

To obtain a higher case letter, press and hold the corresponding letter button.

Description of buttons

Key	Function
Backspace key 	The Backspace key deletes the character to the left of the cursor.
Enter key (return) 	<p>Brief press of the button The enter key terminates a command line. The command you have entered is executed when you press this key.</p> <p>Holding button down The device lock (key lock and display lock) is set or cancelled, see also "Device lock (key and display lock)", Page 68.</p>
Shift key 	<p>The Shift key causes uppercase characters to appear. In the case of overlay keys, the character printed on the upper left of the key appears when that key is pressed.</p> <p>Double-clicking the button Set permanent use of higher case.</p>
FN key 	<p>Pressing the button once The [FN] key activates the special characters or numbers on overlay keys.</p> <p>Holding button down Holding the [FN] key down switches the keyboard backlight on or off.</p> <p>Double-clicking the button Toggle the [FN] key to activate or deactivate FN mode.</p>

Key	Function
Tab key 	The Tab key moves the cursor to the next tab stop.
Start key 	The Start key opens the Windows Start menu.
OK key 	Closes the active window.
Spacebar	Inserts a space.
Symbol key 	<p>Pressing the button once Replaces the current character with a related character with an accent, e.g. the letter “a” is changed to “á”. Up to 5 different related characters are available. Pressing the button again switches to the next available related character.</p> <p>Holding button down A window containing all available characters is opened or closed (if open).</p>
Star key 	<p>Holding button down The Pocket PC is set to Silent Mode, or Silent Mode is deactivated. All tones and the vibration alarm are activated or deactivated.</p>
Inbox application button 	<p>Press the button once Scrolling through voicemail.</p> <p>Hold button down The menu for SMS, MMS and e-mail messaging is called up</p>
Scrolling with 3-way scroll button during a call	Switching off ringtone
Scrolling during a call using the 3-way scroll button	Increasing or decreasing volume
Hold camera application button down	<p>Calling up SpeedMenu</p> <p>Use <i>FSC SpeedMenu</i> to accelerate daily tasks on your Pocket LOOX!</p> <ul style="list-style-type: none"> • Create and organise your own list of frequently used documents, programs and folders. • Open them quickly and directly from the menu. <p>One-handed or stylus operation as desired.</p>
Hold End button down	Calling up profiles

Key combinations (short cuts)

Key combinations are entered as follows:

- ▶ Press and hold the first key in the combination.
- ▶ While holding the first key down, press the second key in the combination.

Key combination	Function
FN + navigation key down	Scroll down
FN + navigation key up	Scroll up
FN + navigation key left	Jump to the start of a list or e-mail
FN + navigation key right	Jump to the end of a list or e-mail
FN and Shift/□Double-click on Shift	Set permanent use of higher case
Shift + navigation key left	Decrease backlight brightness
Shift + navigation key right	Increase backlight brightness
Shift + Del	Delete character to the right of the cursor

Application-dependent key-combinations

Key combinations are a useful way of quickly accessing functions in many applications, e.g. your inbox or the *Phone* function. You can operate the device almost entirely without the pen.

- ▶ Press the right-hand softkey button in the applications.
 - ↳ A menu showing the available functions is displayed.
- ▶ Press the letter which is underlined in the function you wish to execute.
 - ↳ The function is then executed.

Using the pen and display

With the aid of the supplied pen, you can also perform actions by touching the display.

- ▶ Tap the desired element on the display once with the pen to trigger an action.
- ▶ To activate popup menus, again tap the desired element with the pen, but this time leave the pen to rest on the element for a moment. The popup menu appears and you can select an element by touching it.

Using the online buttons for telephony

When you launch the *Phone* application, a window will pop up with the online telephony buttons:

- ▶ enter the required telephone number by touching the display with the stylus.

or

- ▶ Enter the required telephone number via the integrated number block on the keyboard.
 - ↳ You can now make a call, see ["Making a call", Page 28](#).

Using the 3-way scroll button and the navigation key

3-way scroll button

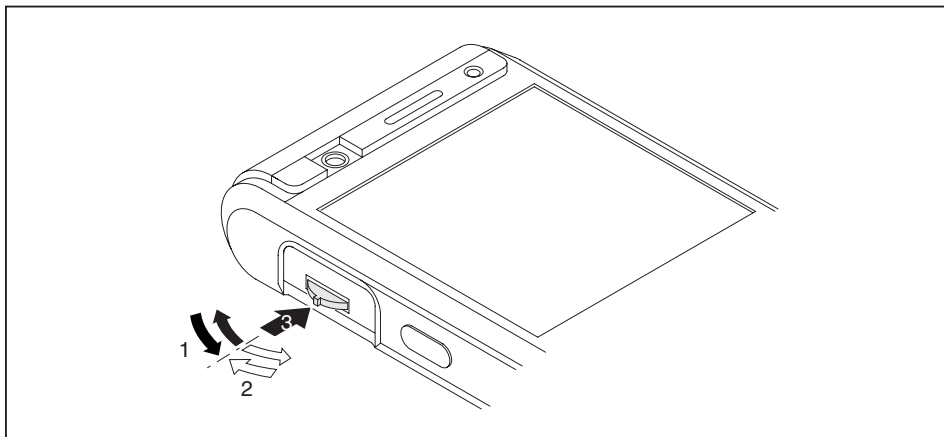

With the scroll button you can scroll up or down and forward or backward (1, 2) within the menu or application. You activate menu entries by pressing the middle scroll button (3).



When you are in the *Phone* application you can use the 3-way scroll button to adjust the phone volume and to switch off the ring tone.

Navigation key

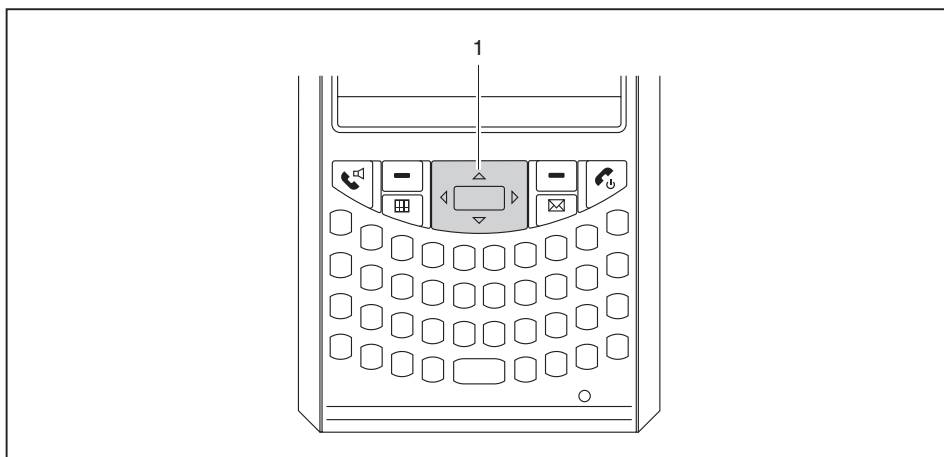

The way in which the navigation key (1) works depends on the application you are in. In some applications you scroll line-by-line up, down, left or right in a menu. To activate menu items press the middle of the navigation key. By contrast, in other applications – e.g. e-mail – you can page up or down with the navigation key.

Using the application buttons and the softkey buttons

Using the application buttons and the appropriate presets (see "[Configuring the application buttons](#)", Page 14) it is possible to open your preferred programs and applications directly from standby mode or from within an application.

As the application buttons react differently dependin on how long they are pressed, you can assign a total of eight different programs or applications to the application buttons.

In addition, your Pocket PC also has two softkey buttons.

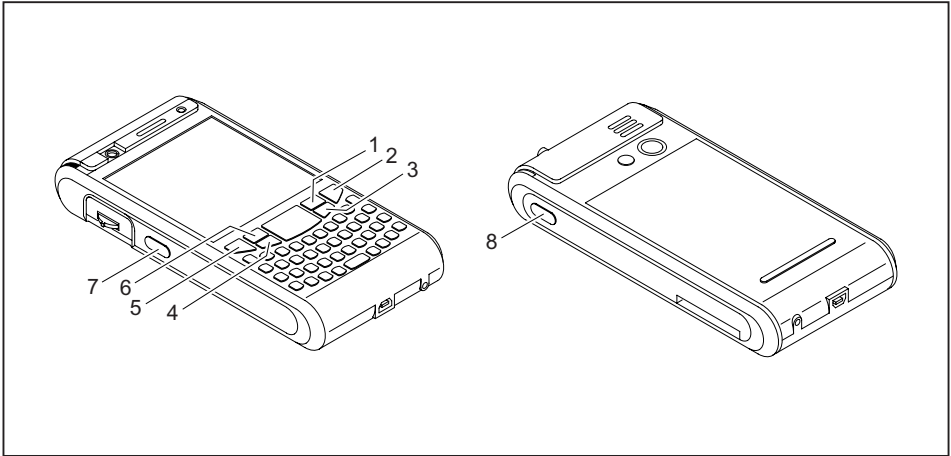

1 = Softkey button 2

2 = End button

3 = Application button 2: Inbox

4 = Application button 1: Calendar

5 = Answer button

6 = Softkey button 1

7 = Application button 5: Camera

8 = Application button 6: Voice note

Button	Allocated function when pressed once	Allocated function when held down
End button	<ul style="list-style-type: none"> • During an active call: ends the call • For an incoming call: refuses the call • In the Today screen: puts the device into Standby mode • In other applications: switches to the Today screen • For active data connections: terminates the data connection <p>Each time you press the button, a connection is terminated (call, data connection) or the device switches to the Today screen. You may have to press the button several times consecutively to put the device in Standby mode.</p>	<ul style="list-style-type: none"> • During a call: ends the call • Otherwise: the Profiles menu is displayed.
Answer button	<ul style="list-style-type: none"> • During an active call: call is held. • For an incoming call: the call is answered. • If no call is active: opens the <i>Telephone</i> application 	<p>During a call:</p> <p>Activates or deactivates the internal loudspeaker (handsfree mode). Any other connected devices, e.g. BT headset or receiver, are deactivated or activated accordingly. This means that the loudspeaker can be activated even with the headset connected.</p>
Softkey button 1	Depends on the particular application.	
Softkey button 2		
Application Button 1	Calendar	New calendar entry.
Application Button 2	Inbox	Creating new messages
Application Button 5	<p>FSC SpeedMenu or camera application (depending on the device type)</p> <p>In the camera application:</p> <ul style="list-style-type: none"> • press once: operates shutter release. • Tap briefly: Autofocus 	FSC SpeedMenu or not assigned (depending on the device type)
Application Button 6	Application for creating voice notes (dictaphone)	Creating a new voice note

Configuring the application buttons

You can also assign other applications or functions to the preselected application buttons.

- ▶ Select *Start – Settings – Personal – Buttons*.
- ▶ Tap the corresponding button in the selection list with the pen.
- ▶ Assign an application or function to the button.
- ▶ Confirm with *OK*.

Using the on-screen keyboard

In some applications which allow text input you will see the symbol for the on-screen keyboard in the footer.

You can use the on-screen keyboard in different ways:

Mode	Description
Symbols	Keyboard showing all available symbols and special characters
Keyboard	Standard on-screen keyboard Touch the keys on the on-screen keyboard to enter text.
Letter Recognizer	Write individual letters, numbers and punctuation marks – they are then converted into typed text.
Block Recognizer	Input text as a connected block of text to write letters, numbers, symbols and punctuation marks which are then converted into typed text. Use gestures to input the Enter key and the Backspace key.
Transcriber	Write using handwriting or block letters, or in a combination of the two, and convert the result into typed text.

Displaying/hiding the on-screen keyboard

- ▶ Touch the symbol for the on-screen keyboard.
- ↳ The on-screen keyboard is displayed on-screen.
- ▶ Touch the symbol for the on-screen keyboard again to close the keyboard.

Changing on-screen keyboard mode

The on-screen keyboard is displayed.

- ▶ Click on the arrow next to the on-screen keyboard symbol.
- ↳ The popup window with the available modes appears.
- ▶ Select your preferred mode.



More information about the on-screen keyboard and its different modes can be found in your Pocket PC's online help function.

Software overview

The following table provides an overview of the most important programs which are already installed on your Pocket PC and where you can find information on using these programs.

Software	Used for	Operating information
<i>Phone</i>	Phone application with video telephony functionality	Help file on Pocket PC
<i>Word Mobile</i>	For word processing	Help file on Pocket PC
<i>Excel Mobile</i>	For spreadsheet functions	Help file on Pocket PC
<i>PowerPoint Mobile</i>	For opening and viewing presentations created on a PC	Help file on Pocket PC
<i>Outlook Mobile</i>	Voicemail, calendar, contacts, notes, tasks	Help file on Pocket PC
<i>ActiveSync</i>	For data synchronisation	Help file on the Pocket PC and on the computer on which you installed <i>ActiveSync</i> .
<i>Internet Explorer Mobile</i>	Browser for websites and WAP sites	Help file on Pocket PC
<i>Windows Media Player Mobile 10</i>	For playing audio and video files	Help file on Pocket PC
<i>Pocket MSN</i>	<ul style="list-style-type: none"> • <i>MSN Messenger</i> for receiving and sending text messages via the Internet • <i>MSN Hotmail</i> for receiving and sending e-mails via an MSN Hotmail account 	Help file on Pocket PC
<i>FSC SpeedMenu</i>	Quick start menu for simplifying daily procedures. Customising the menu to your needs. Support for one-handed operation	Help file on Pocket PC
<i>FSC CONNECTMOBILITY-E2C</i>	Connection manager for efficient management and control of complex Internet and Intranet connections. Automates and minimizes user actions.	Help file on Pocket PC
<i>FSC Voice Recorder</i>	Brings genuine Dictaphone® functionality to the Pocket PC	Help file on Pocket PC
<i>FSC Panning</i>	Experiencing problems when scrolling in <i>Internet Explorer Mobile</i> ? <i>FSC Panning</i> quickly brings window contents into view. Especially useful on large websites.	Help file on Pocket PC

Software	Used for	Operating information
<i>FSC KeyLock</i>	Protects against accidental starting of the Pocket-PC when a key is pressed	Help file on Pocket PC
<i>FSC MobileZip</i>	Open, unpack, create and edit Zip archives	Help file on Pocket PC
<i>FSC Backup (optional)</i>	Data backup and restoration.	Help file on Pocket PC
<i>Voice Commander</i>	Control the device with your voice. For phone calls, calling up information about your contacts and about your programs.	Help file on Pocket PC
<i>GPSLocator</i>	<i>GPSLocator</i> illustrates the basic functions of your GPS system	Help file on Pocket PC
<i>SIM Manager</i>	Manages the data on your SIM card	Help file on Pocket PC

Accessories

We offer a range of accessories to make it easier and more convenient to work with your Pocket PC. Information on additional accessories for your Pocket PC can be found on our website at ["www.fujitsu-siemens.com/accessories"](http://www.fujitsu-siemens.com/accessories).

Below you will find a short description of the specific accessories for your Pocket PC.

Cradle

With the cradle you can charge the battery in the Pocket PC and/or synchronise data between the Pocket PC and a computer.

External GPS antenna (optional)

With a Pocket PC with integrated GPS, you can connect an external GPS antenna to the underside of the Pocket PC. The external GPS antenna improves performance in difficult reception conditions.

Getting started

It will only take a few moments to have your Pocket PC up and running, ready for use. The steps you will need to work through include:

- checking the contents of the package
- removing the protective film from the camera and the screen
- installing the battery and the (optional) SIM card
- connecting the power adapter
- Starting up your Pocket PC for the first time
- Calibrating the touchscreen
- Familiarising yourself with the basic operation of the device
- Performing initial data synchronisation with ActiveSync or Exchange Server (optional)

More information on these individual steps can be found on the "Getting Started" poster and in the following chapters.

Checking the contents of the package

- ▶ Check the contents of your delivery package – use the "Getting Started" poster to make sure nothing is missing.

Removing the protective film from the camera and the screen

The camera lens (optional) and the display are covered with a protective film to protect them against scratches.

- ▶ Before starting up the Pocket PC, remove the protective films on the camera lens and the display.

Installing the battery and the (optional) SIM card

You can use your Pocket PC in two different modes of operation:

- without a SIM card: no telephony functions available
- with a SIM card: telephony functions are available

The SIM card is provided by your telephone network operator. Use of a SIM card is optional. If you choose to use the Pocket PC without a SIM card then the telephony functions will not be available. However, calls to emergency services are also possible without a SIM card.

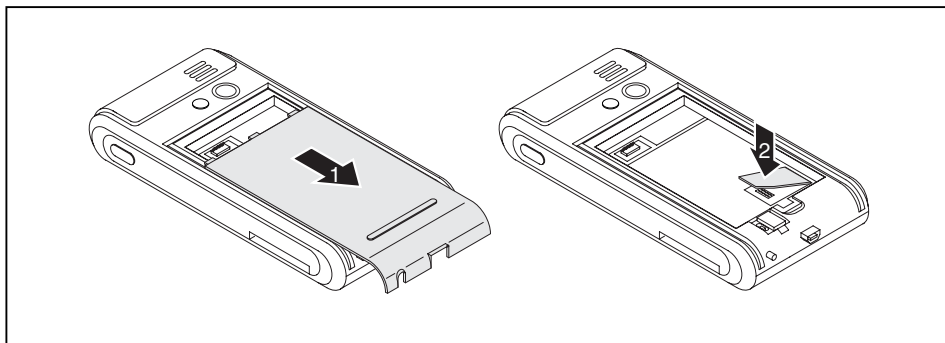

- ▶ Slide the cover off the Pocket PC in the direction of the arrow (1).
- ▶ If using a SIM card, insert it in the direction of the arrow into the SIM card slot (2).

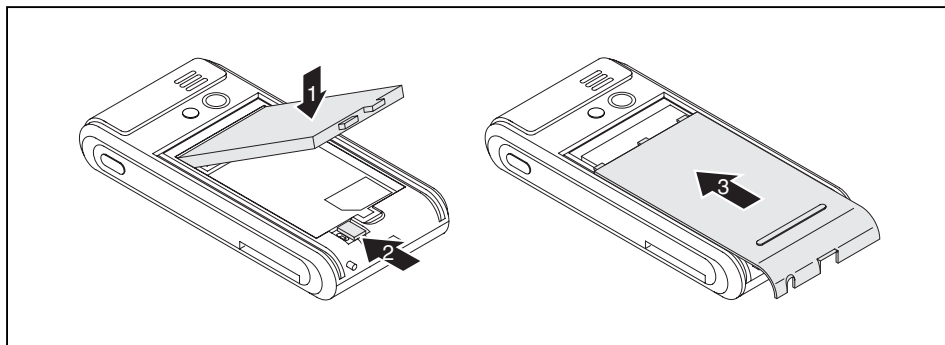

- ▶ Insert the battery into the battery compartment (1).
- ▶ Slide the battery catch in the direction of the arrow (2).
- ▶ Slide the cover back on in the direction of the arrow as far as it will go (3).



Your new battery will not be charged when you unpack it. Therefore, before using the device for the first time without a mains power supply, you should charge the battery until the corresponding LED indicator stops flashing.

Connecting the mains adapter and charging the battery



Pay attention to the relevant safety notes provided in the "Important notes" chapter.

Information on connecting the mains adapter and charging the battery can be found in the ["Operating the Pocket PC", Page 39](#) chapter in the section ["Charging the battery", Page 46](#).

Starting up your Pocket PC for the first time

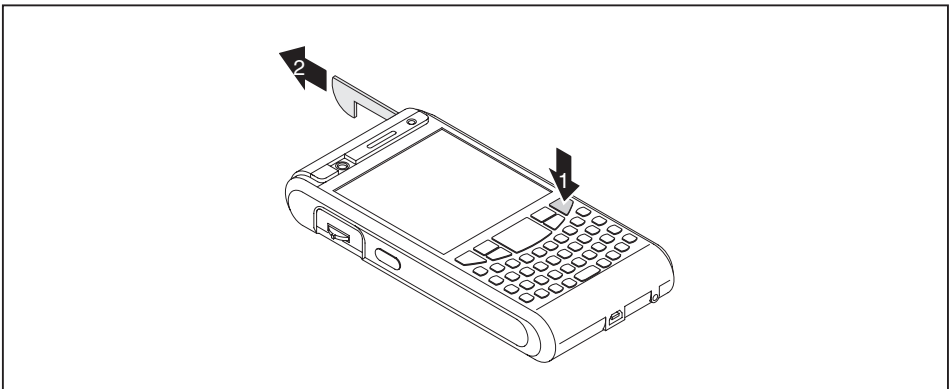

- ▶ Press the End button to switch on the Pocket PC (1).
- ↳ The Pocket PC is switched on.
- ▶ Pull out the stylus in the direction of the arrow (2).

Calibrating the screen

The display of your Pocket PC is a touchscreen. To ensure that the touchscreen of your Pocket PC reacts correctly when touched with the pen, you will be asked to calibrate the touchscreen after the initial start-up.

- ▶ With the stylus, touch the centre of the cross hairs that appear on the screen.
- ▶ You will need to repeat this procedure several times, whereby the cross hairs will appear at different locations on the screen each time.
- ▶ Follow the on-screen instructions.

Entering a PIN (optional)

If you are using a SIM card you will be asked to enter your PIN once the calibration process is finished.

- ▶ Enter your PIN.

Familiarising yourself with the basic operation of the device

The operating system provides a brief introduction on how to use the Pocket PC with the pen after initial start-up.

- ▶ Follow the instructions on the display.

Today screen

After the introduction the Today screen appears. The Today screen shows all important current information at a glance. From this screen you have access to all programs and to the system settings.



Please also use the help function available on your Pocket PC if you want to know more about using the programs contained in the operating system.

Internet and intranet connections with CONNECTMOBILITY-E2C

CONNECTMOBILITY-E2C (E2C in short) is a tool that enables you to establish a connection to the Internet or to your company's intranet very easily by simply pressing a button.

With a few clicks you can change between your company WLAN, your private WLAN at home or a WLAN hotspot in a cafe or at the airport. You can connect to BT or IrDA via your GPRS-enabled telephone without having to think about settings, and start your preferred application automatically.



If you are using a SIM card from one of the major network operators in Europe then the pre-settings of your network operator will be automatically adopted.

Detailed information on the use of *CONNECTMOBILITY-E2C* can be found in the help file on your Pocket PC.

Starting CONNECTMOBILITY E2C

- ▶ Select *Start – Programs – CONNECTMOBILITY-E2C*.
- ↳ *CONNECTMOBILITY-E2C* will start.

User data dialogue

If additional data is required in order to establish the connection to the required target network, e.g. GSM, VPN, WLAN, WPA, PEAP, then these will be requested after the "Connect" softkey has been pressed and before the actual connection is established.

This may be the sort of data given below depending on the type of connection:

- User name
- Password
- Domain
- RSA ID PIN
- RSA ID Token

GPRS/UMTS provider selection

If E2C determines while establishing a connection with a GPRS/UMTS network that you are not in your home country, E2C attempts to read out the home provider of your mobile phone to establish a GPRS/UMTS connection with the related settings. The "GPRS/UMTS provider selection" dialogue will appear if E2C is unable to read your mobile phone's home provider. Here you can provide E2C with the missing data required to automatically establish the GPRS/UMTS connection. E2C requires information on the country and the home provider of your mobile phone from you.

Data synchronisation

Two data synchronisation methods are available:

- Exchange Server
- *ActiveSync*

Data synchronisation via Exchange Server

Exchange Server allows you to synchronise data with a server directly via WLAN or GPRS.

Configuring Exchange Server

- ▶ Select *Start – Programs – ActiveSync*.
- ↳ The *ActiveSync* window will appear on the screen.
- ▶ Select *Menu – Add Server Source* or *Menu – Configure Server*.
- ↳ The Server Settings window is then displayed.
- ▶ Enter the name of the server on which Exchange Server is running.
- ▶ Confirm with *Next*.
- ▶ Enter the user name, password and domain.
- ▶ If necessary click on *Advanced* to change further settings.
- ▶ Confirm with *Next*.
- ▶ Select the data you wish to synchronise via Exchange Server.
- ▶ If necessary click on *Settings* to change further settings.
- ▶ Click on *Finish* to confirm.
- ↳ The data are synchronised with Exchange Server.

Synchronising data with Exchange Server

- ▶ Select *Start – Programs – ActiveSync*.
- ↳ The *ActiveSync* window will appear on the screen.
- ▶ Select *Synchronise*.
- ▶ Enter your password.
- ↳ The data are synchronised with Exchange Server.

Data synchronisation with ActiveSync

ActiveSync allows you synchronise the data on your Pocket PC and your computer (e.g. Outlook data).

You can also use *ActiveSync* to upload new software onto your Pocket PC.

The USB cable and the *ActiveSync* software are provided to facilitate data synchronisation. *ActiveSync* is preinstalled on your Pocket PC. You only need to install *ActiveSync* on your computer.

Installing ActiveSync on your computer

You will find the *ActiveSync* program and the necessary driver on the supplied Microsoft Getting Started CD.

- ▶ Insert the Microsoft Getting Started CD into your computer's optical drive.
- ↳ The *ActiveSync* installation program will start automatically.
- ▶ If the ActiveSync installation program does not start automatically then double-click on the *Setup.exe* file on the *ActiveSync* CD.
- ▶ Follow the instructions on the display.
- ↳ During the installation the software will attempt to establish a connection to the Pocket PC.



If you have not yet installed *Outlook* on your computer, you will need to install it on your computer before synchronising data between your Pocket PC and your computer for the first time.

Performing data synchronisation

After you have specified the desired and required settings for synchronisation in the ActiveSync Setup Wizard on your computer, the first synchronisation starts automatically.

You need to copy the data you have processed on your Pocket PC on the road onto your computer so that you can access the latest version of the data there as well. This procedure is conveniently enabled with data synchronisation:

The *ActiveSync* program allows you specify that the latest version of a file should be identified and then automatically updated on the appropriate data storage device - regardless of whether it is the Pocket PC or the computer.

You can synchronise data between your Pocket PC and your computer via the cradle, using a USB cable or via Bluetooth or wireless LAN.

Information on how to synchronise data using *ActiveSync* can be found in the *ActiveSync* help file on your computer.

Connecting your Pocket PC to a computer

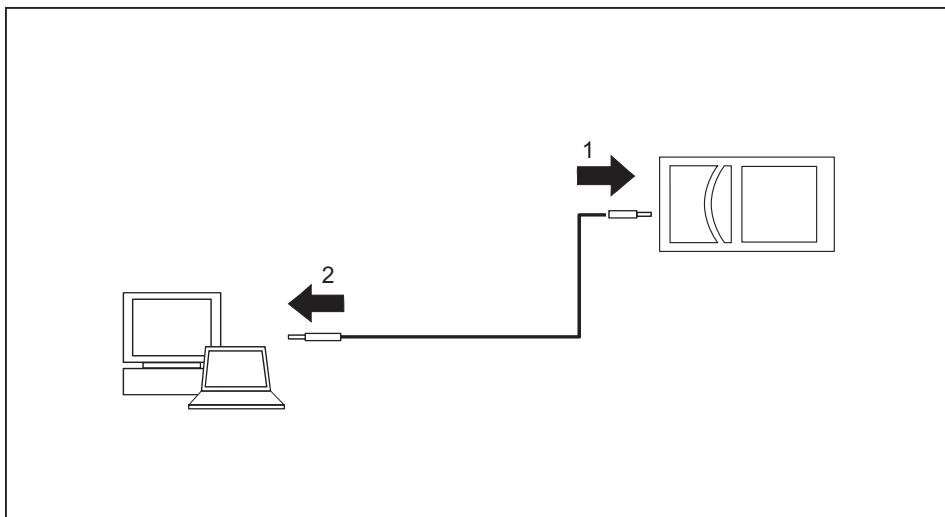

- ▶ Switch the computer on.
- ▶ Connect the USB cable to your Pocket PC (1) and to one of the USB ports (2) of your computer.
- ↳ The Pocket PC is now connected to your computer. The ActiveSync partnership is established between your Pocket PC and computer, and the data are synchronised.



More detailed information relating to data synchronisation with *ActiveSync* can be found in the help file on your Pocket PC.

Using the cradle

With the cradle you can charge the battery in the Pocket PC and/or synchronise data between the Pocket PC and a computer.

The cradle has two mini USB ports: one port for data synchronisation and one port for the mains adapter.

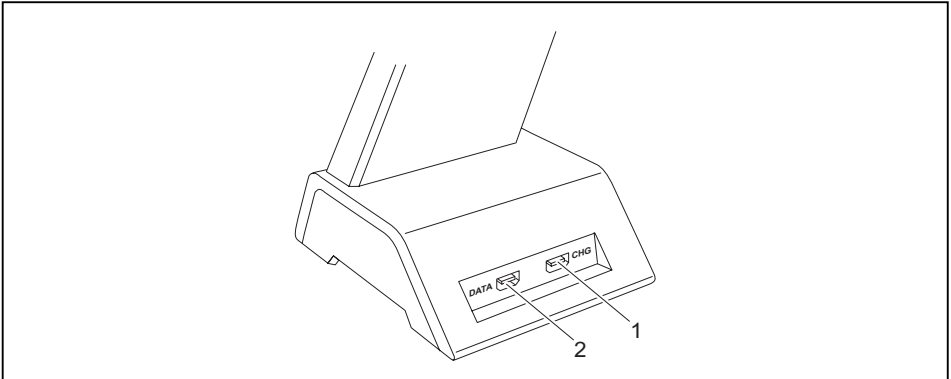

1 = Port for the charging device

2 = Data synchronisation port

Selecting a location for the cradle

Place the cradle on a stable, flat and non-slip surface. In view of the multitude of different finishes used on furniture, it is possible that the rubber feet of the Pocket PC will mark the surface they stand on.

The cradle and the mains adapter should be at least 200 mm apart.

The Pocket PC and the cradle should not be subjected to extreme environmental conditions. Protect the Pocket PC and cradle from dust, moisture and heat.

Using the cradle for data synchronisation



Before synchronising data between your Pocket PC and computer for the first time you will need to install the *ActiveSync* software on your computer (see "Installing ActiveSync on your computer").

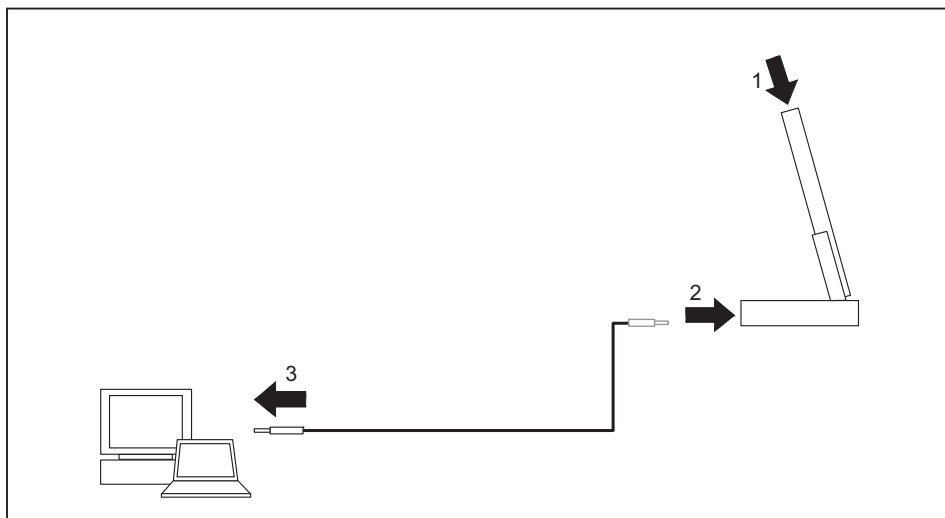

- ▶ Switch the computer on.
- ▶ Place the Pocket PC in the cradle (1).
- ▶ Connect the USB cable to the data synchronisation port of the cradle (2).
- ▶ Connect the USB cable to one of the USB ports of your computer (3).
- ↳ The Pocket PC is now connected to your computer. The ActiveSync partnership between your Pocket PC and your computer is established.
- ▶ If the battery charge level of your Pocket PC is low you should connect the mains adapter (see ["Connecting the mains adapter and charging the battery", Page 19](#)).

More information on data synchronisation can be found in the help file on your Pocket PC.

Using the online help

Your Pocket PC comes with a detailed online help function. You can call up the online help directly or context-sensitively from an application.

Starting the online help independently of an application:

- ▶ Click on *Start – Help*.
- ↳ The Help window opens.
 - Click on *Contents* to view all of the available help topics.
 - Alternatively you can click on *Search* to find specific topics.

Starting the online help from an application

You are in an application.

- ▶ Click on *Start – Help*.
- ↳ A Help window pops up with topics related to the application.

Making telephone calls with the Pocket PC

Your Pocket PC is equipped with all of the functions of a modern mobile telephone. If you have a SIM card from a telephone network operator you can use it. Without a SIM card you will only be able to make calls to the emergency services.

Making a call

The Pocket PC offers you various ways to make telephone calls:

Entering a phone number

You are in the Today screen.

- ▶ Enter the required telephone number via the keyboard.
- ▶ Press the Answer button.
- ↳ The connection is established.

Selecting a phone number from your contacts

- ▶ Click on *Start – Contacts*.
- ↳ Your stored contacts are displayed.
- ▶ Tap the desired contact.
- ↳ The details for the selected contact are then shown.
- ▶ Tap the corresponding telephone number.
- ▶ Press the Answer button.
- ↳ The connection is established.

Select a phone number from your list of calls

- ▶ Press the Answer button.
- ↳ The online keyboard for telephony is displayed.
- ▶ Tap *Call History*.
- ↳ The list of recent calls is displayed.
- ▶ Tap the corresponding telephone number.
- ▶ Press the Answer button.
- ↳ The connection is established.

Making emergency calls

You can make emergency calls with your Pocket PC even if you do not have a SIM card and without entering the PIN or a password.

- ▶ Enter the emergency call number directly.



If your PIN starts with the same numbers as an emergency number (e.g. 999), the characters that are the same as the emergency number may not be encrypted on the screen when you enter the PIN. As soon as you enter a number that is not part of the emergency number, the characters will be encrypted on the screen.

Answering an incoming call

On your Pocket PC, incoming calls are signalled by the selected ringtone/vibration alarm and a corresponding display on the screen.

- ▶ Tap Answer on the screen to pick up the call.

or

- ▶ Press the Answer button.



You can also use the *Ignore* option if you would prefer not to answer the incoming call.

Ending a call

- ▶ Press the End button.

or

- ▶ Tap *End* on the display.

Displaying missed calls

Missed calls are indicated by the right-hand indicator flashing blue and by the word *Notification* appearing on the bottom left of the footer.

- ▶ Touch *Notification* to display the missed call.

or

- ▶ Press the left preset softkey button.
The number of missed calls is displayed.

- ▶ Select *View* to display the caller's telephone number.

or

- ▶ Click on *Dismiss* to close the window without having the telephone number displayed.

Using voice dialling (Voice Commander)

With the aid of the Voice Commander speech recognition application you can save a voice identifier for each of your contacts. Once this has been set up, you only need to say the voice identifier in the Voice Commander application and your Pocket PC will automatically dial the contact's number.



For best results with the Voice Commander system we recommend that you assign the Voice Commander application to one of the application keys – see ["Configuring the application buttons", Page 14](#).

Making a call via Voice Commander

- ▶ Select *Start – Programs – Voice Commander*.
- ↳ Voice Commander is opened. You are prompted to speak a command.
- ▶ Say "call <voice identifier>", e.g. "call test", to dial the contact's telephone number with the corresponding voice identifier.
- ↳ Once Voice Commander has been able to assign your text to a command you will be asked to confirm it.
- ▶ If the command has been correctly recognised say "yes".
- ↳ The phone number of the contact is dialled.



Detailed information on the use of the Voice Commander system can be found in the help file on your Pocket PC.

Speed dial function

You can assign speed dial numbers to up to 99 contacts. These speed dial numbers allow you to dial required telephone numbers more quickly.

Programming the speed dial function

- ▶ Click on *Start – Contacts*.
- ↳ Your stored contacts are displayed.
- ▶ Tap the required contact.
- ↳ The details for the selected contact are then shown.
- ▶ Choose an available speed dial number, e.g. "29".
- ▶ Confirm with *OK*.
- ↳ The speed dial number for your contact has now been saved.

Making a call via the speed dial number

From the *Today* screen or the telephone application:

- ▶ press and hold the speed dial number assigned to the desired number.
- ↳ The connection is established.

Using the hands-free function

With the aid of the hands-free function you can make calls via the loudspeaker without having to hold the telephone to your ear. In the process, the loudspeaker volume and the microphone sensitivity are significantly increased.

- ▶ Press the Answer button.
- ↳ The online keyboard for telephony is displayed.
- ▶ Enter the telephone number with the stylus.
- ▶ Press the Answer button.
- ↳ The connection is established.
- ▶ Touch *Speaker On*.

or

- ▶ Press and hold the Answer button.
The hands-free function is now active, and the loudspeaker is switched on.
- ▶ Touch *Speaker off* to turn off the loudspeaker.

or

- ▶ Press and hold the Answer button.

Muting the telephone

During a call you can mute the microphone of your Pocket PC to prevent the other person from being able to hear what you or someone else in the room is saying.

- ▶ Press the Answer button.
- ↳ The online keyboard for telephony is displayed.
- ▶ Enter the call number.
- ▶ Press the Answer button.
- ↳ The connection is established.
- ▶ Tap *Mute*.
- ↳ The microphone is switched off.
- ▶ To switch the microphone back on tap *Unmute*.

Holding a call

This function allows you to put a call on hold without disconnecting it. In this case the person at the other end of the line will hear music while he or she is on hold. In the mean time you can for example dial a second telephone number and set up a second telephone connection.

- ▶ Press the Answer button.
- ↳ The online keyboard for telephony is displayed.
- ▶ Enter the telephone number.
- ▶ Press the Answer button.
- ↳ The connection is established.
- ▶ Tap *Hold*.
- ↳ The call is put on hold. While it is on hold, the person at the other end of the line hears music.
- ▶ If you would like to set up a second telephone connection, touch the keyboard in the footer and dial the required number.
- ▶ To terminate the second call tap *End*.
- ▶ Touch *Swap* to speak to the first person again.



You can also combine two held calls into a conference call – see ["Making a conference call", Page 32](#).

Making a conference call

You have established two phone connections, see ["Holding a call", Page 32](#). You would like to combine these two calls to a conference call.

Setting up a conference call

- ▶ Tap *Menu – Conference*.
- ↳ All connections are combined to a conference call.

Disconnecting all connections from the conference call

- ▶ Tap on *End*.
- ↳ All connections are disconnected.

Disconnecting selected connections

- ▶ Tap *Menu – Private*.
- ↳ All active connections are displayed.
- ▶ Tap on the connection you would like to disconnect.
- ▶ Tap on *End*.
- ↳ The selected connection is terminated. All other connections remain connected.

Making video phone calls (optional)

Depending on the equipment level, your Pocket PC is supplied with a camera which enables you to make video phone calls. Video phone calls are also possible if the person receiving the call has video functionality without the corresponding camera.



Please check with your phone network operator whether separate activation is required for this service.

GPRS does not support video telephony. Video phone calls can only be made via a UMTS connection.

The quality of the video phone call depends largely on the strength of the UMTS network. The video phone call will be interrupted in the event of network fluctuations.

Answering an incoming video phone call

On your Pocket PC, incoming video phone calls are signalled by the selected ringtone/vibration alarm and a corresponding display on the screen.

- ▶ Tap Answer on the screen to pick up the call.

or

- ▶ Press the Answer button.

↳ The video camera on the front of the device is activated, the camera window appears in the display and the connection is established.

You can also use the *Ignore* option if you would prefer not to answer the incoming call.

- ▶ Position yourself in front of the video camera so that your picture is shown clearly on the Pocket PC display.

Making a video phone call

You are logged into a UMTS network.

- ▶ Press the Answer button.

↳ The *Phone* application will be displayed.

- ▶ Enter the required phone number.

- ▶ Select *Video Call*.





↳ The video camera on the front of the device is activated, the camera window appears in the display and the connection is established.

- ▶ Position yourself in front of the video camera so that your picture is shown clearly on the Pocket PC display.

↳ Once a connection has been successfully established, the display on the Pocket PC will show the picture of the person you are calling.

Further options for video phone calls

Further video telephony options are available in the *Phone* window:

Option	Meaning
	Interrupts the video transmission without terminating the video phone call.
	Mutes the microphone.
	Switches between the cameras. By default the camera on the front of the device is used for video phone calls. This function allows you to switch to the 2 megapixel autofocus camera on the back of the device.
	Changes the video settings: <ul style="list-style-type: none"> • both video pictures are the same size. • Only the video picture of the person making the call is shown. • Own video image is large, video image of the other person is small. • Own video image is small, video image of the other person is large.
End	Terminates the video phone call.

Managing contacts

The Pocket PC offers you two ways to save contact details:

- use the "Contacts" application to save the contact details directly onto your Pocket PC.
- Store the contact details on the SIM card (optional)

The "Contacts" application on your Pocket PC offers an address book with comprehensive functions. You can save your contact data in a local address book on your Pocket PC.



Detailed information on the use of the "Contacts" application can be found in the help file on your Pocket PC.

Copying contact details from the Pocket PC to the SIM card

The "Contacts" application also allows you to copy contact data from the local address book on your Pocket PC to your SIM card.



The "Contacts" application displays both contacts from the local address book and contacts from the currently used SIM card. Contacts on the SIM card are marked with the SIM card symbol.

- ▶ Click on *Start – Contacts*.
- ↳ The contacts are displayed.
- ▶ Tap the required contact.
- ↳ The contact is opened.
- ▶ Select the menu - *Save to SIM*.
- ↳ The contact is copied to the SIM card.

Copying contacts from the SIM card to the Pocket PC

With the aid of the SIM Card Manager you can display the contact data on the SIM card and copy them to your Pocket PC.

- ▶ Select *Start – Programs – SIM Contacts*.
- ↳ The SIM Card Manager is opened with the contact data saved on the SIM card.
- ▶ Select *Copy now* to transfer the contact data from the SIM card to your Pocket PC.
- ↳ The contact data are copied across.

Displaying services on the SIM card (network provider specific)

With the aid of the "SIM Toolkit" application you can also display the services, e.g. Info-Services, made available by your telephone network provider via your SIM card.

- ▶ Select *Start – Programs – SIM Toolkit*.
- ↳ The available services are displayed.



Please contact your telephone network provider for more information about the services available.

SIM security

If you are operating your Pocket PC with a SIM card, the system will ask you to enter your PIN number whenever you switch the phone function on or off, completely shut down the device or change the battery and/or the SIM card.

However, you can also deactivate the PIN request in the device settings if you would prefer to start up your Pocket PC without being asked for your PIN number:

- ▶ Select *Start – Settings – Phone*.
- ▶ Place a tick next to the option *Require PIN when phone is used*.
- ↳ The PIN is no longer requested when the device is started up.

SIM Lock



Depending on your phone network provider, your Pocket PC may have a SIM lock, i.e. you may not be able to use your device with SIM cards from other network providers.

For more information about how to cancel the SIM lock, please contact your phone network provider.

Blocking the SIM card

The SIM card is provided by your phone network operator.



Please contact your phone network operator if you would like to have your SIM card blocked.

Configuring phone settings

The SIM card for telephony functions is provided by your phone network operator. As a result, the phone settings depend to a large extent on the functions made available by your phone network provider.



Detailed information on the configuration of phone settings can be found in the help file on your Pocket PC.

Selecting a network

If you use more than one network you can define one of the networks as your preferred network.

- ▶ Select *Start – Settings – Personal*.
- ▶ Select *Phone*.
- ↳ The window for setting the *Phone* application will then be displayed.
- ▶ Select the *Network* tab.
- ▶ Select *Find network*.
- ↳ Your network connections are updated.
- ▶ Tap on *Set Networks*.
- ↳ The strongest network is automatically selected.
- or
- ▶ From the network selection options select *Manual*.
- ↳ A list of the available networks is displayed.
- ▶ Choose your preferred network.
- ▶ Confirm your settings with *OK*.
- ↳ The network is selected.

Setting up a Voicemail number



The voicemail number is provided by your phone network provider.

- ▶ Click on *Start – Settings – Personal – Phone – Services*.
- ▶ In the scroll menu select the entry *Voicemail and Text Messages*.
- ▶ Select *Get Settings*.
- ↳ The settings are read in from the network.
- ▶ Enter your Voicemail number under *Voicemail*.
- ▶ Confirm with *OK*.
- ↳ The voicemail number is set up.

Setting up the SMS Service Centre



The number of your SMS Service Centre is provided by your phone network provider and may already be preset.

- ▶ Click on *Start – Settings – Personal – Phone – Services*.
- ▶ In the scroll menu select the entry *Voicemail and Text Messages*.
- ▶ Select *Get Settings*.
- ↳ The settings are read in from the network.
- ▶ Enter your SMS Service Centre number under *Text Messages Service Number*.
- ▶ Confirm with *OK*.
- ↳ The SMS Service Centre is set up.

Call Forwarding

With your Pocket PC you can forward incoming calls – e.g. when your device is switched off, or if you are currently using a different telephone, or in case you are already answering another call on the line:

- ▶ click on *Start – Settings – Personal – Phone – Services*.
- ▶ Select *Call Forwarding* from the scroll menu.
- ▶ Select *Get Settings*.
- ↳ The settings are read in from the network.
- ▶ Enter the desired settings for the call forwarding.
- ▶ Confirm with *OK*.

Operating the Pocket PC

This chapter contains descriptions of the operating elements of your Pocket PC as well as information about how to use it.



Please refer to the notes in the chapter ["Important notes", Page 3.](#)

Using your Pocket PC's profiles

Default profiles provide convenient access to frequently used system settings, tailored to the particular way in which you are using the device. With the aid of these profiles you can control power consumption or the radio modules of your device. You can also use profiles to control data behaviour and the acoustic/visual behaviour.

Profile	Description
<i>Standby</i>	The Pocket PC is switched to Standby mode.
<i>Complete Off</i>	The Pocket PC is completely switched off.
<i>Flight mode</i>	All radio modules (phone, WLAN, Bluetooth) are deactivated. The Pocket-PC is operated as a handheld only.
<i>Direct Push</i>	Deactivates or activates the E-mail push function, see "Receiving e-mails and other data automatically in real-time (e-mail push) ", Page 59.
<i>Outdoor</i>	Mode for loud environments. The volume of acoustic signals is increased.
<i>Metting mode</i>	Acoustic signals are switched off. Vibration function is active.
<i>Normal Mode</i>	The volume of the acoustic signals corresponds to the standard volume of the device.
<i>Maximum performance</i>	Mode for high-speed working with comparatively high power consumption.
<i>Maximum battery</i>	Energy saving mode.
<i>Automatic mode</i>	The Power Manager determines the optimum power consumption mode and the processor performance. The CPU automatically switches between the power profiles according to the required use.
<i>BT carkit</i>	Switches the Pocket PC to Bluetooth hands-free (optional).



If you would like to switch off the vibration function as well as the system tones, you can activate silent mode by pressing and holding the star key.

Selecting profiles

- ▶ In the Today screen, press and hold the End button.
- ↳ The profile list is displayed.
- ▶ Use the navigation key to select the desired profile.
- ↳ The profile is activated.
- ▶ Confirm with the Enter key.

Configuring profiles

- ▶ In the Today screen, press and hold the End button.
- ↳ The profile list is displayed.
- ▶ Use the navigation key to select the desired profile.
- ▶ Select *Menu – Edit*.
- ▶ Enter the settings for the profile and confirm with *OK*.
- ↳ The new profile settings are saved.



Detailed information on the configuration of the profiles can be found in the help file on your Pocket PC.

Switching the Pocket PC on and off

The Pocket PC is switched on and off with the End button. After certain applications or the installation of new programs, it may be necessary to restart the Pocket PC with a soft reset. It is only necessary in rare and exceptional cases to restore the Pocket PC's factory defaults.

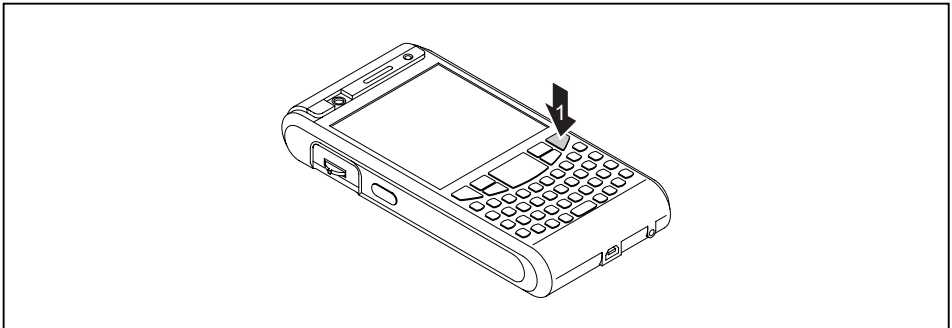

1 = End button

Switching the Pocket PC off and on during normal use (Standby mode)

Switching the Pocket PC to Standby mode

- ▶ From the Today screen, press the End button once.
- ↳ The Pocket PC is switched to Standby mode.



If you have specified a switch-off time in the system settings, your Pocket PC will automatically switch to Standby mode after this specified time.

There are two ways to switch on your Pocket PC:

Switching on with the End button

- ▶ Press the End button once.
- ▶ If the device lock is activated, press and hold the Enter button.
- ↳ The Pocket PC is switched on.

Switching on with the application buttons

By default, you can also switch your Pocket PC on by briefly pressing one of the application buttons.

- ▶ Press any one of the application buttons once.
- ↳ The applications assigned to the respective button appear on the screen.



You can prevent the Pocket-PC being started accidentally if the application buttons are pressed by selecting the appropriate setting in *FSC KeyLock*.

Detailed information about *FSC KeyLock* can be found in the help file on your Pocket PC.

Switching off the Pocket PC to save the battery

- ▶ In the Today screen, press and hold the End button.
- ↳ The profile list is displayed.
- ▶ Select the *Complete off* profile.
- ↳ The profile is activated. All programs are closed and the Pocket PC is completely switched off. The power consumption of the Pocket PC is reduced to a minimum.
- ▶ To switch the Pocket PC back on again, press and hold the End button.

Resetting the Pocket-PC

Soft reset (warm start)

After certain applications or the installation of new programs, it may be necessary to restart the Pocket PC with a soft reset.



Unsaved data will be lost. Shut down all programs before you restart the Pocket-PC.

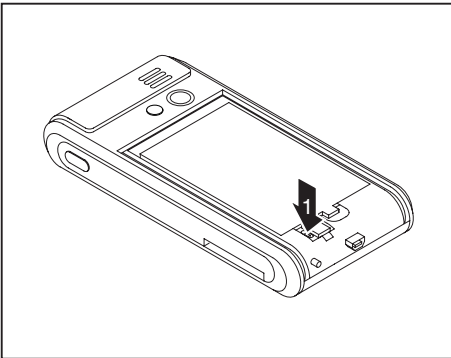

- ▶ Slide off the battery cover from the Pocket PC.
- ▶ Press the stylus tip once into the soft reset opening (1).
- ↳ The warm boot is carried out.

Cold starting and restoring factory default settings

If your Pocket PC stops working and switching off and on with the End button and the soft reset is unsuccessful, you can perform a cold start with your Pocket PC or restore the factory default settings.



Unsaved data will be lost. Only carry out a cold start and reset when the battery is fully charged.

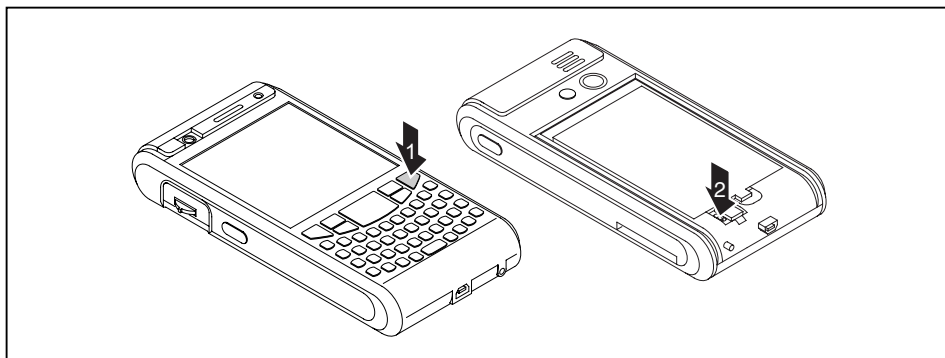

- ▶ Slide the battery cover from the Pocket PC.
 - ▶ At the same time press and hold the End button (1) and press the tip of the stylus pen into the soft reset opening (2).
 - ▶ Release the End button as soon as a list of possible options is displayed on the screen.
 - ▶ Select *Skip* if you would like to perform a normal cold start.
 - ▶ To restore the Pocket PC to the factory defaults select *Factory Defaults*.
- ↳ The selected option is performed.

It may take a few minutes for the factory defaults to be restored. At the end an acoustic signal sounds. Please follow the further instructions on the display.



The data memory is deleted when the Pocket PC is restored to its factory defaults. This means: you will lose all data (documents, additionally installed programs, personal settings) that you haven't saved elsewhere. Always back up your data on a regular basis (memory card, *FSC Backup*).

If you have set a password using *FSC SecureLock* then this password will be retained.

Out and about with the Pocket PC

Please observe the following information when you are out and about with your Pocket PC.

Transporting the Pocket PC

- ▶ Switch the Pocket PC off.
- ▶ Disconnect the cables from the Pocket PC.
- ▶ If the device needs to be shipped, use the original packaging or other suitable packaging to protect it against knocks and bumps.
- ▶ Use a bag for the Pocket PC when transporting it. The bag offers protection against knocks and bumps and is available as an accessory.
- ▶ In some countries the use of Bluetooth is restricted or completely prohibited. Ask about the regulations in the country you will be travelling to before starting your trip. As a precaution, switch Bluetooth off in case there is any uncertainty at your place of residence.
- ▶ Protect the Pocket PC from severe shocks and extreme temperatures (e.g., direct sunlight in a car).



If you are travelling abroad, check that the mains adapter can be operated with the local mains voltage. Do not use any other voltage converter!

In-flight usage

- ▶ If you wish to use your Pocket PC during a flight as a pure handheld without telephony functions, Bluetooth or WLAN, check with the airline first whether and under what conditions this is allowed.
- ▶ Before embarking on the flight, make sure that you switch off all telephony functions, Bluetooth and WLAN functions. To do this, select the "Flight mode" profile – see ["Using your Pocket PC's profiles", Page 40](#).

Usage while driving

- ▶ Use a hands-free system, e.g. a hands-free installation in the vehicle or the optional Bluetooth headset, and select the BT hands-free profile before you start driving – see ["Using your Pocket PC's profiles", Page 40](#).

Cleaning the Pocket PC

- ▶ Switch the Pocket PC off.
- ▶ Pull the power plug out of the mains outlet.



Do not use any cleaning agents that contain abrasives or may corrode plastic. Please ensure that no liquid enters the Pocket PC.

- ▶ Clean the surface of the device with a dry cloth.
- ▶ If it is very dirty, you can clean the device and the display with a damp cloth.

Charging the battery

Your Pocket PC is equipped with a powerful battery. When you're on the road, your Pocket PC is powered by the built-in battery.



The battery is not charged on delivery and should be charged prior to the first mobile use.

You have three ways of recharging the battery:

- you can connect the Pocket PC directly to an electrical outlet with the mains adapter.
- You can connect the cradle to an electrical outlet with the power adapter and insert the Pocket PC into the cradle.
- You can connect the Pocket PC to a computer's USB port using a USB cable.

You can continue to work with the Pocket PC when charging the battery. This extends the charging time.



Please read the information about the mains adapter in the ["Connecting the mains adapter and charging the battery", Page 19](#) chapter.

Charging the battery directly via the mains adapter

You can connect the mains adapter directly to the Pocket PC.

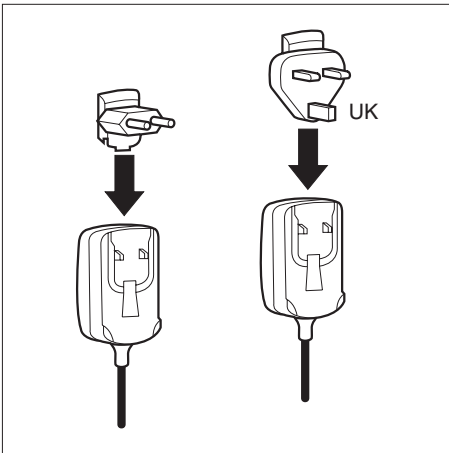

- ▶ Push the matching mains adapter plug into the mains adapter in the direction of the arrow until it engages.

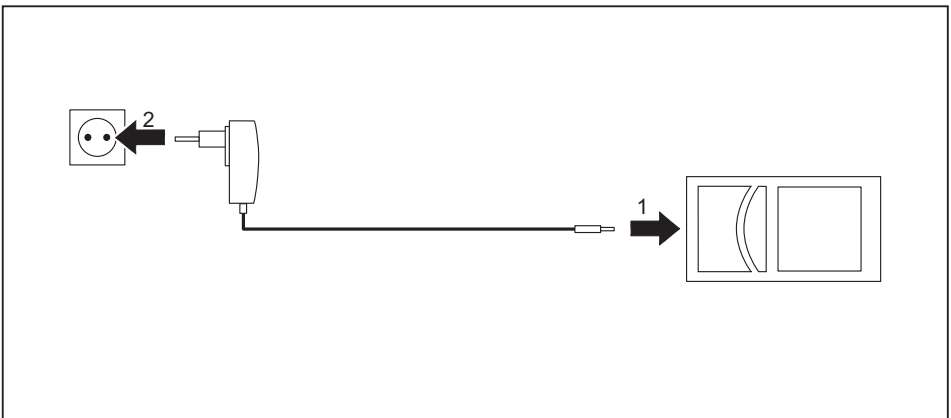

- ▶ Connect the mains adapter cable to the mini USB port on the Pocket PC (1).
- ▶ Plug the mains adapter into a mains outlet (2).
- ↳ The installed battery will now be charged. The power-on indicator flashes orange. When the battery is fully charged, the orange battery indicator lights continuously.

Charging the battery via the cradle

You can connect the mains adapter to the cradle:

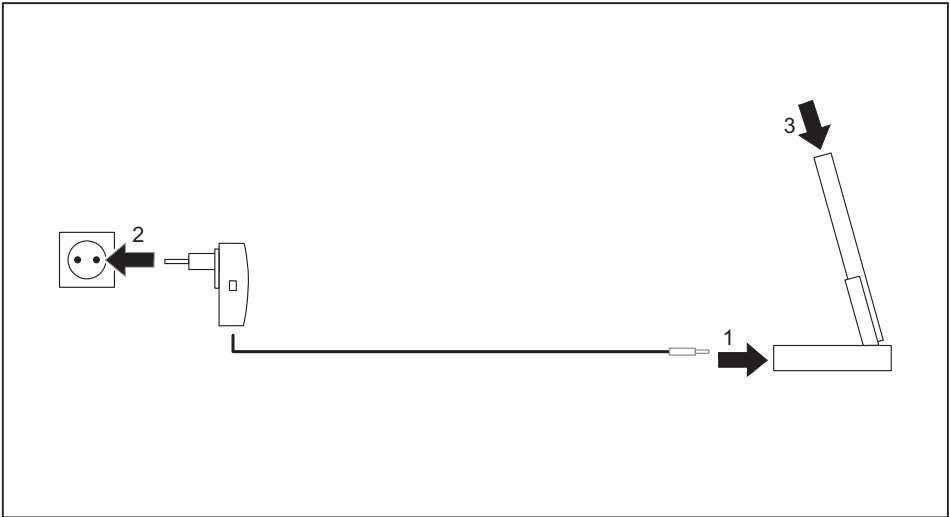

- ▶ Connect the mains adapter cable to the charging device port on the cradle (1).
 - ▶ Plug the mains adapter into a mains outlet (2).
 - ▶ Place the Pocket PC in the cradle (3).
- ↳ The installed battery will now be charged. The power-on indicator flashes orange. When the battery is fully charged, the orange battery indicator lights continuously.

Charging the battery via a USB port

- ▶ Connect the USB cable to your Pocket PC.
- ▶ Connect the USB cable to the computer's USB port.



Depending on the charge current the charging process may take longer than with a mains adapter.

Optimising battery life

When you have completely charged the battery, you can operate the Pocket PC without a mains power connection. However, it is not possible to exactly specify the maximum operating time, as some applications use more energy than others.

You can use the system settings to select options that help save energy when using your Pocket PC – see "[Energy saving functions](#)", [Page 72](#). Doing this will help you to optimise battery life.

Inserting and removing an expansion card

There is a slot available for an expansion card of the type "Secure Digital I/O" or "MultiMediaCard".



Observe the manufacturer's instructions when using the expansion cards.

Never use force when inserting or removing an expansion card.

Make sure that no foreign objects enter the slot.

Inserting an expansion card

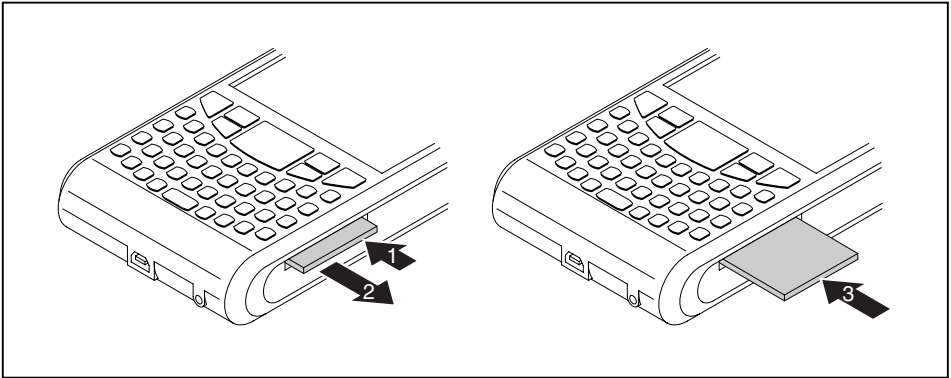

- ▶ If necessary, press on the edge of the placeholder so that the placeholder protrudes slightly from the slot (1).
 - ▶ Pull the placeholder out of the Pocket PC (2).
 - ▶ Carefully push the expansion card into the slot (3).
- ↳ The expansion card can protrude by one to several millimetres (depending on the type of expansion card).



Keep the placeholder for the expansion card in a safe place. When you remove the expansion card again, you should reinsert the expansion card placeholder. This will prevent any foreign matter from entering the slot.

Removing the expansion card

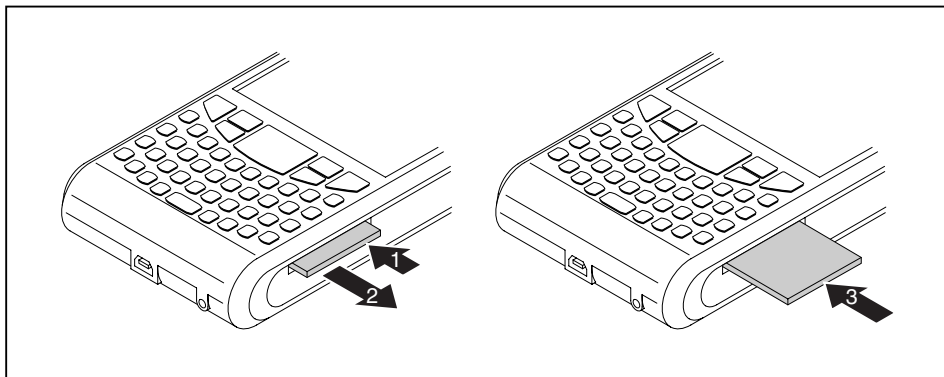

- ▶ Press on the edge of the expansion card so that the expansion card protrudes slightly from the slot (1).
 - ▶ Slide the expansion card out of the Pocket PC (2).
 - ▶ Insert the placeholder into the slot again (3) if necessary.
- ↳ The placeholder protrudes by one to two millimetres.

Using the Pocket PC as a USB Host device

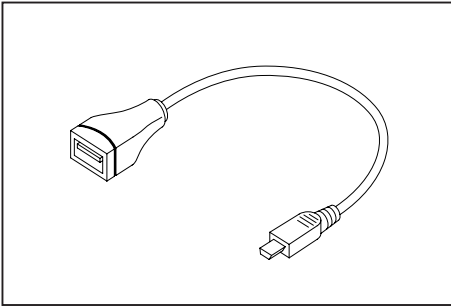

With the optional USB Host cable you can use your Pocket PC as a USB Host device and connect various USB devices, such as a MEMORYBIRD, to the Pocket PC.



You can connect USB devices from Fujitsu Siemens Computers (e.g. MEMORYBIRD or STORAGEBIRD) immediately.

If you want to connect other USB devices, ask your dealer whether you will need to install corresponding drivers first.

The current consumption of the USB device must not exceed 100 mA (at +5 V). USB devices with a current consumption of more than 100 mA must be supplied with power via their own power supply.

- ▶ Select *Start – Settings – System – USB mode*.
- ↳ The window for selecting the USB mode pops up.
- ▶ Select the *USB Host* option.
- ▶ Confirm with *OK*.
- ▶ Connect the USB Host cable to the mini USB port on the Pocket PC.
- ▶ Connect the USB device (such as a MEMORYBIRD) to the USB port of the USB Host cable.
- ↳ The USB device is now connected to your Pocket PC.
- ▶ If the battery charge level of your Pocket PC is low you should connect the mains adapter (see ["Connecting the mains adapter and charging the battery", Page 19](#)).
- ▶ When you no longer need to operate the Pocket PC as a USB Host, change the USB mode back to *USB Client*.

Configuring device settings



Detailed information about how to configure device settings such as the date, time, alarms, background images, tones, and application and task displays can be found in the help file on your Pocket PC.

Customising menus

Frequently used programs appear in the Start menu. You can adapt the Start menu to meet your needs.

▶ Tap on the *Menus* symbol under *Start – Settings – Personal*.

↳ A list of programs/applications appears.

To remove programs from the Start menu, click the program's checkbox. The check mark is removed from the checkbox.

To add programs to the Start menu, click the checkbox of the desired program. A check mark appears in the checkbox.

Fast access to programs via FSC SpeedMenu

Do you want fast access to programs but all application buttons are already assigned? Do you always open the same documents and folders? Do you sometimes miss having an extra hand for using the stylus?

Use *FSC SpeedMenu* to accelerate daily tasks on your Pocket LOOX!

- Create and organise your own list of frequently used documents, programs and folders.
- Open them quickly directly from the menu.
- One-handed or stylus operation as desired.



Detailed information on this topic can be found in the help file on your Pocket PC.

Creating messages

Just like any other mobile phone, you can use your Pocket PC to send SMS and MMS messages as well as e-mails.

Incoming messages are indicated by the LEDs (see "[Indicators \(LEDs\) and status indicators in the display](#)", Page 5), a message on the screen and, depending on the device settings, either a signal tone or vibrating alarm.

Inbox

You can use the Inbox to check and manage all incoming and sent message types (SMS, MMS, e-mail), as well as to create and send new messages.

The last messaging application that was used is always active in the window, e.g. MMS or e-mail.

All message types have their own account with subfolders.

- Delete items
- Drafts
- Inbox
- Outbox
- Sent items

With the aid of the *Sort By* menu you can also display the messages by certain criteria:

- Message Type
- Sender
- Received
- Subject

Use the *New* function to create a new message of the currently selected message type.

Displaying the inbox

- ▶ Click on *Start – Messaging*.
- ↳ The inbox is displayed.
- ▶ Select the required message type and the required subfolder via the *Inbox*.
- ↳ All messages of the selected type are displayed.

SMS

You can also use your Pocket PC to create SMS text messages in exactly the same way as a normal mobile phone. Each SMS can contain a maximum of 160 characters.

Creating and sending SMS

- ▶ Click on *Start – Messaging*.
- ▶ Click on the *Inbox* dropdown menu.
- ▶ Tap on the *SMS Account*.
 - Select *New*.
- ↳ A window opens for writing the new SMS.
- ▶ Enter the SMS addressee and the desired text message.
- ▶ Select *Send*.
- ↳ The SMS is sent.



Detailed information on SMS can be found in the help file on your Pocket PC.

Managing SMS on the SIM card

The SMS Manager allows you to display all of the messages stored on your SIM card, transfer them to your Pocket PC or delete them from the SIM card.

- ▶ Select *Start – Programs – SMS Manager*.
- ↳ The SMS manager is displayed together with the SMS saved on the SIM card.
- ▶ Select the desired SMS.
- ▶ Select *Save – Save to Inbox* to copy an SMS message into the Inbox on your Pocket PC.
- ▶ Select *Save – Save all to Inbox* to copy all SMS into the Inbox on your Pocket PC.
- ▶ To delete an SMS message from the SIM card select *Delete – Delete From SIM*.
- ▶ To delete all SMS messages from the SIM card select *Delete – Delete All From SIM*.
- ▶ Select *OK* to exit the SMS Manager.

MMS

MMS (Multimedia Messaging Service) messages are messages which can contain multimedia objects like pictures, sound or video clips (3GP, MP4, AVI, WMV). You can attach files with a maximum size of up to 300 kB.

You will need to configure your MMS application before you can send any MMS messages, see ["Configuring the MMS application", Page 55](#).



Your telephone network provider will generally provide you with the data for your MMS connection.

Configuring the MMS application

In order to configure your MMS application, you will need to define your MMS connection and an MMS profile.

Configuring the MMS connection

- ▶ Click on *Start – Settings*.
- ▶ Select the *Connections* tab.
- ▶ Select the *Connections* symbol.
- ▶ Select *Advanced*.
- ▶ Select *Select network*.
- ▶ Click on *New* under *Use programs with automatic Internet access*.
- ↳ The *ISP name* window will appear on the screen.
- ▶ Enter *MMS* in this field.
- ▶ Select the *Modem* tab.
- ▶ Select *New*.
- ▶ Enter the name "My connection" under *Enter a name for the connection*.
- ▶ Select the entry *Cellular Line (GPRS)* from the *Select modem* dropdown list.
- ▶ Select *Next*.
- ↳ The *My Connection* window will appear on the screen.
- ▶ Enter the name for the access point provided by your telephone network provider under *Access point name*.
- ▶ Select *Next*.
- ▶ Enter the user name, password and domain given to you by your telephone network provider.
- ▶ Click on *Finish* to confirm your entries.
- ↳ Your MMS connection is configured.

Configuring the MMS profile

You are in the Today screen. Your MMS connection is configured.

- ▶ Click on *Start – Messaging*.
- ↳ The inbox is displayed.
- ▶ Click on *Menu – MMS Settings*.
- ↳ The *Settings* window will appear on the screen.
- ▶ Choose any profile and tap *Edit*.
- ↳ The Profile Settings window is displayed.
- ▶ Enter the profile settings provided by your telephone network provider.
- ▶ Click on *Finish* to confirm your entries.
- ↳ Your MMS profile is configured.

Creating and sending MMS messages

- ▶ Click on *Start – Messaging*.
- ▶ Click on the *Inbox* dropdown menu.
- ▶ Tap on the MMS account.
- ▶ Select *New*.
- ↳ The window with the new MMS is opened.
- ▶ Enter the addressee and the subject of the MMS.
- ▶ To attach a picture or video clip select *Menu – Insert – Picture* or *Menu – Insert – Video* and select the picture or video you would like to attach.
- ↳ The picture or video clip is displayed in the MMS window.
- ▶ To attach an audio file select *Menu – Insert – Voice note* and select the audio file you would like to attach.
- ↳ The audio file is displayed in the MMS window.
- ▶ To attach a different file type, select *Menu – Insert – File* and select the file.
- ↳ The file is displayed in the MMS window.
- ▶ Select *Enter text* and type in your text message.
- ▶ Select *Send*.
- ↳ The MMS message is sent.

E-mail

With the Pocket PC you have various options for sending and receiving e-mails:

Private mail:

- Via your ISP's POP3, SMTP or IMAP4 account

Company mail:

- via a VPN corporate network
- Via *ActiveSync*

In order to be able to send e-mails you will therefore need a suitable e-mail account from your ISP or a suitable e-mail account on a VPN corporate network (Virtual Private Network).

Setting up e-mail accounts for POP3, SMTP or IMAP4

- ▶ Click on *Start – Messaging*.
- ▶ Click on the *Inbox* dropdown menu.
- ▶ Click on the e-mail account.
- ▶ Select *Menu – Tools – New Account*.
- ▶ Enter the required data.
- ▶ Click on *Finish* to confirm your entries.

Setting up an e-mail account for the VPN corporate network



Your ISP or administrator will generally be able to provide you with the data for your e-mail account.

- ▶ Select *Start – Programs – ActiveSync*.
- ↳ The *ActiveSync* window will open.
- ▶ Select *Menu – Add Server Source* or *Menu – Configure Server*.
- ↳ The Server Settings window is opened.
- ▶ Enter the server address.
- ▶ Confirm with *Next*.
- ▶ Enter the user name, password and domain.
- ▶ Click on *Finish* to confirm your entries.

Setting up sending e-mail via ActiveSync

- ▶ To connect your Pocket PC to your computer see ["Connecting your Pocket PC to a computer", Page 24](#).
- ▶ Follow the on-screen instructions.

Creating and sending e-mails

With your Pocket PC you can easily send e-mail messages with attachments (photos, voice notes, files).

- ▶ Click on *Start – Messaging*.
- ▶ Click on the *Inbox* dropdown menu.
- ▶ Tap on the e-mail account.
- ▶ Select *New*.
- ↳ The window with the new e-mail is opened.
- ▶ Enter the addressee, the subject and the desired message.
- ▶ Select *Send*.
- ↳ The e-mail is sent.



Detailed information on creating and sending messages can be found in the help file on your Pocket PC.

Downloading e-mails from a server (e-mail pull)

The process for downloading e-mails from a server depends on your e-mail account:

- If you have an Outlook e-mail account, then you can transfer your e-mails via ActiveSync to your handheld device – see ["Data synchronisation with ActiveSync", Page 22](#).
- If you have an ISP e-mail account or a VPN server connection, then you will need to log on to the Internet or network.
 - ▶ Click on *Start – Messaging*.
 - ▶ Click on the *Inbox* dropdown menu.
 - ▶ Tap on the e-mail account.
 - ▶ Select *Menu – Send/Receive*.
- ↳ Any new e-mails on the server are transferred to the Pocket PC, and e-mails in the "Outbox" folder of your Pocket PC are transferred to the server for sending.

Receiving e-mails and other data automatically in real-time (e-mail push)

If you have a data connection to a mobile network provider (GPRS/UMTS) for your Pocket PC then your e-mails, calendar data, contact data, tasks etc. can be delivered from the network to your Pocket PC in real-time via e-mail push.

If your device is switched off (Standby mode) when new data are received via e-mail push, then the LED will start to flash.

The following conditions must be met in order to use e-mail push:

- The server must support e-mail push.
- Exchange Server 2003 Service Pack 2 is installed.
- Direct Push has been set up by your administrator on your Pocket PC.



Please consult your administrator if you have any queries.

In general, e-mail push should already be activated on your device after being set up by the administrator.

To deactivate e-mail push, you will need to deactivate the corresponding profile on your Pocket PC:

- ▶ In the Today screen, press and hold the End button.
- ↳ The profile list is displayed.
- ▶ Select the *Direct Push* profile.
- ↳ The profile is deactivated.
E-mail push is deactivated.
- ▶ To reactivate e-mail push, select the *Direct Push* profile again.
- ↳ The profile is activated.



Detailed information on adjusting the device behaviour when e-mail push is activated can be found in the ["Configuring device behaviour when E-mail push is activated", Page 73](#) chapter.

Using the Internet

In order to use the Internet you will need to have Internet access via an ISP or on a VPN corporate network (Virtual Private Network).

In some cases your Internet access may already be pre-configured on your device. If this is the case, all you need to do is to launch Internet Explorer – see "[Accessing the Internet with Internet Explorer](#)", Page 60.

Otherwise you can configure your Internet access via *FSC CONNECTMOBILITY-E2C*. Detailed information on this topic can be found in the help file on your Pocket PC.



Your ISP or administrator will be able to provide you with the required Internet access data.

Accessing the Internet with Internet Explorer

The *FSC CONNECTMOBILITY-E2C* can be used to set up a connection to the Internet or to your company's intranet via WLAN, GSM or GPRS at the push of a button.

Your Pocket PC uses Internet Explorer Mobile as its Internet browser. This offers extensive browser functionality.

Calling up Internet Explorer Mobile

You have selected the desired connection type with *FSC CONNECTMOBILITY-E2C* and established a connection.

- ▶ Select *Start – Internet Explorer*.
- ↳ Internet Explorer is displayed.



Detailed information on the use of Internet Explorer Mobile and *FSC CONNECTMOBILITY-E2C* can be found in the help file on your Pocket PC or in chapter "[Internet and intranet connections with CONNECTMOBILITY-E2C](#)", Page 20.

Using GPS functions

With a GPS receiver and navigation software you can use the Pocket PC as a navigation system. Depending on the equipment, the GPS receiver is either integrated or available as an external accessory.



Map materials for your Pocket PC are available from retailers on DVD or on memory cards or via an online shop.

You have two options for using the navigation software on your Pocket PC:

- you can use the navigation software on a preinstalled expansion card.
- You can install the navigation software via your computer, e.g. from a DVD.



To register your navigation software you will require the serial number of the navigation software and possibly also the device ID of your Pocket PC.

Where necessary, the device ID will be displayed after the initial start-up of the navigation software.

- ▶ Register your navigation software and your map materials as described in the instructions for the navigation software.



If the reception signal is weak, you can connect an external GPS antenna. The external GPS antenna improves performance under difficult reception conditions.

The external GPS antenna is available as an accessory.

GPS connects to COM6 at 9600 Bit/s.

Detailed information on this topic can be found in the help file on your Pocket PC.

- ↳ A description of how to use the navigation software is provided in the instructions on the navigation software.

FSC GPSLocator

FSC GPSLocator is demonstration software that illustrates the functions of the GPS receiver in your Pocket LOOX device.

The GPS receiver will also be activated when you start the *FSC GPSLocator*. Exiting the program deactivates the GPS receiver.

The GPS module is calibrated when you switch it on for the first time. This can take several minutes. Whenever you start the device again, your GPS receiver will be ready for use in just a few seconds.

Inside a building you will not normally be able to receive a GPS signal. It is therefore best to calibrate the GPS receiver out in the open.

GPSLocator shows you the GPS coordinates of your current location. If you are on the move with the device – either on foot or in the car – the direction of movement and your speed are also displayed.

The *POI Finder* is an application that helps you to find your way back to a previously stored position.

Using the camera (optional)

Depending on its equipment level, your Pocket PC will come with two integrated cameras: one VGA camera on the front and one 2 megapixel autofocus camera on the back of the device (resolution: 1600 x 1200).

You can use the VGA camera for video telephone calls – see "[Making video phone calls \(optional\)](#)", Page 33.

With the 2 megapixel autofocus camera you can record both individual still photographs as well as short video sequences.

2 megapixel autofocus camera

Supported file formats:

file type	Formats
Pictures	BMP, JPG
Video Call	AVI, WMV, MPEG4, 3GP

Starting the Pictures & Videos application

You can create and manage pictures and videos using the Pictures & Videos application.

- ▶ Select *Start – Programs – Pictures & Videos*.
- ↳ This will open the *Pictures & Videos* application.

Starting the camera directly

- ▶ Push application button 5: Camera
- ↳ The camera is started.

Taking pictures

The camera window is open.



You can focus manually by gently pressing application button 5.

- ▶ To take a picture, press application button 5.
- ↳ The picture is taken and displayed in the Pictures & Videos window as a full-size picture.
- ▶ Select *Camera* to take more pictures.
- ▶ Select *OK* to return to the overview of all pictures and videos.

Recording a video sequence

This will open the *Pictures & Videos* application.

- ▶ Select *Camera*.
- or
- ▶ Tap the *Camera* symbol.
- ↳ The camera window opens.
- ▶ Select *Menu – Video*.
- ↳ The camera is switched to video mode.
- ▶ To start the video recording, press application button 5.
- ↳ The video recording starts.
- ▶ To stop the video recording, press application button 5 again.
- ↳ The video recording stops.
- ▶ If you would like to record more video sequences, press application button 5 again.
- ▶ Select *OK* to return to the overview of all pictures and videos.

Configuring the camera and video settings

Further options for using the camera are available from the menu whenever camera mode or video mode is active.

Camera settings

Option	Meaning
<i>Video Call</i>	This option switches the camera to video mode.
<i>Mode</i>	With this option you can choose between different recording modes: <ul style="list-style-type: none"> • Normal: For taking individual shots. • Burst: For taking a sequence of 5 shots • Timer: Self timer option (5-second delay)
<i>Brightness</i>	Adjustment of the brightness settings
<i>Screen resolution</i>	Adjustment of the image resolution
<i>Zoom</i>	Adjustment of the zoom settings
<i>Options</i>	Various options are available for changing settings (image size, slide show, file location etc.).
<i>White balance</i>	Adjustment for ambient light
<i>Flicker</i>	Sets the image frame rate (50/60 Hz)

Video settings

Option	Meaning
<i>Still</i>	This option switches the camera to photo mode.
<i>Brightness</i>	Adjustment of the brightness settings
<i>Quality</i>	Adjustment of the video quality settings
<i>Options</i>	Various options are available for changing settings (image size, slide show, file location etc.).



Detailed information on this topic can be found in the help file on your Pocket PC.

Working with data

Windows Media Player

You can play back various audio and video formats on your Pocket PC using *Windows Media Player*:

File type	Formats
Audio	WMA, MP3, WAV
Video Call	WMV, MPEG4



You can find detailed information on how to use the Windows Media Player in the help file on your Pocket PC.

Using Java applications

The *JBlend* program allows you to run Java applications for mobile devices and to download them from the Internet and install them on your device.

Downloading Java applications

- ▶ Select *Start – Programs – JBlend*.
- ↳ The program and the available Java applications are displayed.
- ▶ Select *Download*.
- ↳ Internet Explorer is displayed.
- ▶ Enter the desired Internet address.
- ▶ Download the desired Java application.
- ↳ You will be asked if you wish to install the Java application.
- ▶ Confirm with *Yes*.

Starting Java applications

- ▶ Select *Start – Programs – JBlend*.
- ↳ The program and the available Java applications are displayed.
- ▶ Tap on the Java application you wish to start.
- ↳ The Java application is started.

Uninstalling Java applications

- ▶ Select *Start – Programs – JBlend*.
- ↳ The program and the available Java applications are displayed.
- ▶ Select the Java application you wish to uninstall.
- ▶ Select *Menu – Delete*.
- ↳ You will be asked if you wish to uninstall the Java application.
- ▶ Confirm with *Yes*.

Compressing files with FSC MobileZip

FSC MobileZip lets you open, unpack, create and edit Zip archives.

FSC MobileZip extends the popup menu in the File Explorer: If you hover over a file, you will see additional entries in the popup menu, with which you can quickly create and extract archives.

FSC MobileZip supports archives up to a size of 4 GB as well as password protection with simple encryption.



You can find detailed information on how to use *FSC MobileZip* in the help file on your Pocket PC.

Security functions

Your Pocket PC can be protected or locked in several ways:

Lock	Meaning
Password protection	For password protection provided by the <i>Microsoft Windows 5.0 Phone Edition</i> operating system, see " Password protection ", Page 67 . Password protection is lost if the device's the factory settings are restored.
Device lock (key and display lock)	Protects the device by locking the controls to prevent accidental input during operation, see " Device lock (key and display lock) ", Page 68 .
FSC KeyLock	Prevents the device from being reactivated when an application key is pressed when in standby mode (disabled status), see " FSC KeyLock ", Page 68 .
FSC SecureLock (optional)	Protects the device against access by third parties by requesting a password, see " FSC SecureLock (optional) ", Page 69 . Password protection is retained even if the device is reset to the factory settings and offers special anti-theft protection A stolen device is worthless.
SIM Lock	Enables the device only if a specific SIM card is used (performed by the phone network operator), see " Making telephone calls with the Pocket PC ", Page 28 , section "SIM Lock". Prevents the device from being used with other SIM cards.
Phone Lock	When the Phone Lock is activated, the telephone can only be used in conjunction with your SIM card. This function is useful in case you lose the device. It may be that your provider also sets the device so that it can only be used in conjunction with a SIM card offered by that provider.

Password protection

You can use a password to protect your Pocket PC against unauthorised use. This makes your data accessible only to persons who know the password.



If *FSC SecureLock* has been set, then this password protection cannot be cancelled until the *FSC SecureLock* has been cleared.

- ▶ Tap on the *Password* symbol under *Start – Settings – Personal*.
- ▶ Select the type of password you prefer:
 - A password consisting of four numbers (simple 4-digit password).
 - A password of alphanumeric characters (a complex alphanumeric password).

If a password has been assigned, you will have to enter this password the next time you switch on.

If you have forgotten your password you can restart your Pocket PC by restoring the factory settings (see "[Cold starting and restoring factory default settings](#)", [Page 44](#)).

Device lock (key and display lock)

With the device lock (key and display lock) you can lock the following elements and functions of the device during active operation in order to prevent accidental inputs:

- Application buttons
- Keyboard
- Display
- Accept an incoming call via the Answer button
- Ending a call via the End button



The device can be switched off even when the device lock is active.

Locking the device

- ▶ Press and hold the Enter key.
- ↳ The device is locked.

Deactivating the device lock

- ▶ Press and hold the Enter key.
- or
- ▶ Press Unlock and the star key consecutively.
 - ↳ The device is unlocked.

FSC KeyLock

Use the *FSC KeyLock* to prevent accidental "activation" of your Pocket LOOX. For example, if the device is in your pocket.

Normally, the device is activated if one of the application or telephone keys is pressed.

Activating FSC KeyLock

- ▶ Click on *Start – Settings – Personal – Buttons – FSC KeyLock*.
- ▶ Activate *Application buttons locked*.

Switching on with lock active

- ▶ Briefly press the End button.
- ▶ Then press and hold the Enter key.

FSC SecureLock (optional)

To protect your Pocket PC and your data from unauthorised access by third parties, you can protect it with a password.

- ▶ Tap on *Start - Settings - System - Secure Lock*.
- ▶ Activate the *Theft protection* control box.
- ▶ Select the desired type of password from the *Password type* field. Enter the password and confirm it if necessary.
- ▶ Enter a term on the *Note* tab page that will remind you of your password if necessary, but which will not enable other users to guess your password.
- ↳ This term is displayed if the password has been entered incorrectly several times.
- ▶ Tap *OK*.
- ↳ If your Pocket PC is reset to the factory settings, you will be prompted to enter the password.

Connecting and networking the Pocket PC with other devices

The Pocket PC offers a wide range of ways to exchange data with other devices or to work in a network.

In addition, the wireless LAN (optional) and Bluetooth (optional) radio modules are available for wireless communication.

This chapter provides information on wireless data transfer

- Via wireless LAN
- Via Bluetooth

Activating and deactivating radio modules

You can use Wireless Manager to activate or deactivate the telephone, Bluetooth and WiFi/WLAN.

You are in the Today screen.

- ▶ Tap on the telephone symbol.
- ↳ The Wireless Manager is displayed.
- ▶ To activate or deactivate the telephone, Bluetooth or WiFi/WLAN touch the symbol next to *WiFi*, *Bluetooth* or *Phone*.

or

- ▶ To activate or deactivate all components tap on the symbol next to *All*.
- ↳ The selected component is activated or deactivated.

Wireless connection via Wireless LAN

Your Pocket PC is equipped with an integrated wireless LAN. Information on this topic is provided in the help file on your Pocket PC. You can establish WLAN connections using the *CONNECTMOBILITY-E2C* software.



You can find more information on the *CONNECTMOBILITY-E2C* software in the ["Internet and intranet connections with CONNECTMOBILITY-E2C"](#), Page 20 section and in the help file on your Pocket PC.

Wireless communication with Bluetooth

If your Pocket PC has an integrated Bluetooth module you can communicate wirelessly with other Bluetooth devices, e.g. with another Pocket PC, a computer or a mobile phone.

You can establish Bluetooth connections via the *BT Manager*. Start the *BT Manager* via the FSC SpeedMenu, see ["Fast access to programs via FSC SpeedMenu", Page 52](#).

Example:

you want to use a Bluetooth headset.

- ▶ Enter a new "Handsfree/headset" device in *BT Manager*.
- ▶ Follow the on-screen instructions.



You can find detailed information on the "BT Manager" in the help file on your Pocket PC.

Selecting location for Bluetooth operation

- We recommend that you use the Bluetooth enabled Pocket PC in a typical operating environment. Other Bluetooth devices, which you want to communicate with, should be located at a distance of up to 10 m.
- Install a partner device only within the recommended distance. Observe the output power class of the partner device when doing so. Details are contained in the operating manual for the partner device.
- Use the Bluetooth-enabled Pocket PC at least 2 m away from other electrical or electronic systems. If you must use the Pocket PC near a microwave cooker, then maintain a distance of at least 3 m from the microwave cooker, as the reception is subject to interference from the microwaves.
- Should problems result when communicating via Bluetooth because radios or radio devices are located in the vicinity, then move the Pocket PC to a different location.

Energy saving functions

The Pocket PC uses less power when the energy saving functions are enabled. This means you can work with the Pocket PC for longer before having to recharge the battery.

General information on energy management

The battery operating time depends greatly on the applications used. Please note that a particularly large amount of energy is required to play sound files or make sound recordings.

Exchanging data with a computer also consumes additional battery power. Therefore always connect your Pocket PC to an electrical outlet when exchanging data if possible.

Using energy saving functions

You can save energy in several ways to optimally utilise the battery operating time:

configuring Standby mode

- ▶ Under *Start – Settings – System – Power* select the number of minutes after which the Pocket PC is to switch into the Standby mode when not being used.
- ↳ After the specified time has passed, the Pocket PC will automatically be set to standby mode.



Press the End button to end standby mode. The Pocket PC returns to the point at which you interrupted your work.

Switching off backlight

- ▶ Under *Start – Settings – System – Backlight* select the number of minutes after which the display lighting is to be switched off if the Pocket PC is not used and is running in battery mode.

Configuring backlight

You can adjust the backlight on your Pocket PC to make it darker or brighter. Reduce the display brightness to save energy.

- ▶ Click on *Start – Settings – System – Backlight – Brightness*.
- ▶ Use the slide control to adjust the backlight when the battery and/or an external power supply is being used, until the desired level of brightness is reached.
- ▶ Confirm with *OK*.



The backlight can also be configured by pressing the key combination **Shift** + left or right Navigation key.

Configuring Keyboard backlight

- ▶ Select *Start – Settings – System*.
- ▶ Select Keyboard backlight.
- ↳ The window for adjusting the keyboard backlight is displayed.
- ▶ Set the desired duration of the keyboard backlight for use in battery mode and for use with an external power supply.
- ▶ Confirm with *OK*.



Keyboard backlighting can also be activated and deactivated by pressing and holding the **FN** key.

Configuring device behaviour when E-mail push is activated

You can configure how your device should behave when E-mail push is activated. Usually, the device LED starts flashing when new information is being received. However, you can change this behaviour.

- ▶ In the Today screen, press and hold the End button.
- ↳ The profile list is displayed.
- ▶ Use the navigation key to select the desired profile.
- ▶ Select *Menu – Edit*.
- ▶ Enter the settings for E-mail push and confirm with *OK*.

Switching off the sound and setting the volume

- ▶ Tap on the loudspeaker symbol in the title bar.
- ↳ A popup window for the loudspeaker settings appears.
- ▶ Set the desired volume on the slide control with the stylus.
- ▶ To switch off the sound, activate the *Off* selection field with the stylus.
- ▶ Tap the display anywhere outside the popup window.



Device sounds can also be activated and deactivated by pressing and holding the star key.

Wireless connection via Wireless LAN

Your Pocket PC is equipped with an integrated wireless LAN. Information on this topic is provided in the help file on your Pocket PC. You can establish WLAN connections using the *CONNECTMOBILITY-E2C* software.



You can find detailed information on the *CONNECTMOBILITY-E2C* software in the EasyGuide and in the help file on your Pocket PC.

Using Wireless Manager

You can use Wireless Manager to manage the energy status of telephone, Bluetooth and WiFi/WLAN.

You are in the Today screen.

The Wireless Manager is displayed.

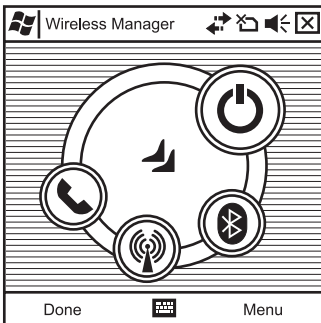

- ▶ To activate or deactivate the telephone, Bluetooth or WiFi/WLAN, touch the corresponding *WiFi*, *Bluetooth* or *Phone* symbol.
 - or
 - ▶ Tap the *On/Off* symbol to activate or deactivate all components.
- The selected component is activated or deactivated.

Symbol	Meaning
	On/Off
	Phone
	Bluetooth
	Wi-Fi

Troubleshooting and tips

If a fault occurs in your Pocket PC, try to fix it with the measures described in this chapter. If you fail to correct the problem, proceed as follows:

- ▶ Make a note of the steps and the circumstances that led to the fault. Also make a note of any error messages displayed.
- ▶ Switch the Pocket PC off.
- ▶ Contact your sales outlet or our hotline/help desk.

Installing new software

You will find information on installing supplementary programs in the *ActiveSync* help file that will be available to you after installing *ActiveSync* on your computer.

- ▶ When installing programs or drivers, important files may be overwritten and modified. You should make a backup before the installation so that you can still access the original files after installation should an error occur (see ["Data synchronisation with ActiveSync", Page 22](#)).

The Pocket PC's time or date are not correct

Cause	Troubleshooting
Time and date are incorrect.	<ul style="list-style-type: none"> ▶ Tap on the <i>Clock</i> symbol under <i>Start – Settings – System</i>. ▶ Changing the time <p>or</p> <ul style="list-style-type: none"> ▶ Connect your Pocket PC to your computer via <i>ActiveSync</i>. ▶ Synchronise data between the Pocket PC and the computer. The time and date are also synchronised in the process.

The Pocket PC's display remains dark

Cause	Troubleshooting
Backlight is switched off.	<ul style="list-style-type: none"> ▶ Press and hold the End button.

The display is difficult to read

Cause	Troubleshooting
Reflected glare	<ul style="list-style-type: none"> ▶ Turn the Pocket PC until you can see the information in the display again.

The Pocket PC switches off

Cause	Troubleshooting
The battery is flat.	<ul style="list-style-type: none"> ▶ Connect the power adapter to the Pocket PC to charge the battery. <p>or</p> <ul style="list-style-type: none"> ▶ Connect the power adapter to the cradle and insert the Pocket PC into the cradle to charge the battery. The battery is charging. The power-on indicator flashes orange.

The Pocket PC does not start after being switched on

Cause	Troubleshooting
The battery is flat.	<ul style="list-style-type: none"> ▶ Connect the power adapter to the Pocket PC to charge the battery. <p>or</p> <ul style="list-style-type: none"> ▶ Connect the power adapter to the cradle and insert the Pocket PC into the cradle to charge the battery. The battery is charging. The power-on indicator flashes orange.
The power adapter is not connected correctly.	<ul style="list-style-type: none"> ▶ Switch the Pocket PC off. ▶ Check whether the power adapter is properly connected to the Pocket PC and the electrical outlet. ▶ Switch the Pocket PC on again.

The Pocket PC does not respond any more

Cause	Troubleshooting
An application program has caused the malfunction.	<ul style="list-style-type: none"> ▶ Restart the Pocket PC (see "Switching the Pocket PC on and off", Page 41). <p>or</p> <ul style="list-style-type: none"> ▶ If the restart does not work then reset the Pocket PC to the factory settings (see "Cold starting and restoring factory default settings", Page 44).
The battery is flat.	<ul style="list-style-type: none"> ▶ Connect the power adapter to the Pocket PC to charge the battery. <p>or</p> <ul style="list-style-type: none"> ▶ Connect the power adapter to the cradle and insert the Pocket PC into the cradle to charge the battery. The battery is charging. The power-on indicator flashes orange.

The battery discharges too quickly

Cause	Troubleshooting
The battery is either too hot or too cold.	<ul style="list-style-type: none"> ▶ Bring the Pocket PC up / down to a normal temperature again. <p>If the battery operating time is extremely short, the battery is probably too old and should be replaced. Please contact your dealer for a new battery.</p>

The End button does not respond properly

Cause	Troubleshooting
You have pressed the End button for too long to switch the Pocket PC on or off.	<ul style="list-style-type: none"> ▶ Press the End button until the Pocket PC switches on or off.

No sound or minimal volume

Cause	Troubleshooting
Volume set wrongly.	<ul style="list-style-type: none"> ▶ Tap the loudspeaker symbol in the navigation bar. A popup window for the loudspeaker settings appears. ▶ Activate the selection field for <i>On</i> using the stylus. <p>or</p> <ul style="list-style-type: none"> ▶ Set the desired volume on the slide control with the stylus.

Poor reception via GPS

Cause	Troubleshooting
Your Pocket PC's installed position in your vehicle is poor.	<ul style="list-style-type: none"> ▶ Change the Pocket PC's installed position.
Your vehicle's windscreen is coated.	<ul style="list-style-type: none"> ▶ Use an external GPS antenna (available as an accessory).

Contact with hotline/help desk

If you are unable to solve a certain problem, please contact the hotline/help desk. Additional details are given in the "Safety" and "Warranty" manuals. Please have the following information ready when you call:

- the model name and serial number of the Pocket PC. The serial number is located on a sticker on the back of the Pocket PC.
- Notes of any messages that appear on the screen and information on acoustic signals.
- Any changes you have made to the hardware or software after receiving the Pocket PC.
- Your system configuration and all peripheral devices connected to your system (e. g. keyboard).
- Your sales contract.
- Your IMEI number.

The Fujitsu Siemens Computers hotline or help desk requires the device information for your Pocket PC in order to process your problem. You can find this information directly on your device:

Calling up the IMEI number

The IMEI number (International Mobile Equipment Identity) is a 15-digit serial number, which is used to uniquely identify your Pocket PC.

▶ Select *Start – Settings – System – System Information*.

▶ Select *Identity*.

↳ The IMEI number is displayed.

Calling up the UUID

The UUID (Universally Unique Identifier) is a globally unique 16 or 28 bit number, that is also used to identify your device.

▶ Select *Start – Settings – System – System Information*.

▶ Select *Identity*.

↳ The UUID is displayed.

Technical data

General	Pocket LOOX T810	Pocket LOOX T830
Processor	Intel® PXA270 416 MHz based on Intel® XScale™ micro-architecture	Intel® PXA270 416 MHz based on Intel® XScale™ micro-architecture
Memory	System memory (RAM): 64 MB Flash memory (ROM): 128 MB	System memory (RAM): 64 MB Flash memory (ROM): 128 MB

Pocket PC

Electrical data	Pocket LOOX T810	Pocket LOOX T830
Regulations complied with	CE, FCC Part 15 Class B, EN 60950, UL, cUL	CE, FCC Part 15 Class B, EN 60950, UL, cUL
Protection class	III	III
Maximum performance draw (Pocket PC on with battery charging)	5 W	5W

Display	Pocket LOOX T810	Pocket LOOX T830
Transflective TFT display	2.4 inch, 240 x 240 colours, 16,536 colours, LED background lighting	2.4 inch, 240 x 240 colours, 16,536 colours, LED background lighting

Card slots	Pocket LOOX T810	Pocket LOOX T830
	"Secure Digital I/O", "MultiMediaCard"	"Secure Digital I/O", "MultiMediaCard"

Ports/interfaces	Pocket LOOX T810	Pocket LOOX T830
Input/output port	USB 1.1	USB 1.1
Audio	Microphone, loudspeaker, headphones (3.5 mm), □ receiver for GSM/UMTS calls	Microphone, loudspeaker, headphones (3.5 mm), □ receiver for GSM/UMTS calls
Bluetooth	Bluetooth 2.0	Bluetooth 2.0
Wireless LAN	802.11 b/g, WiFi certified	802.11 b/g, WiFi certified
GPS	SiRF Star III	SiRF Star III

Cameras	Pocket LOOX T810	Pocket LOOX T830
Camera 1	–	VGA camera (640 x 480) for video telephony via UMTS
Camera 2	–	2 mega pixel auto-focus camera (1600 x 1200) for images/video

Baseband	Pocket LOOX T810	Pocket LOOX T830
UMTS/GSM/GPRS Baseband	EMP U250 GSM 900/180/1900 UMTS 2100	EMP U250 GSM 900/180/1900 UMTS 2100

Environmental conditions	Pocket LOOX T810	Pocket LOOX T830
Environment class 7K1/7K2	IN IEC 721 EN 60721	DIN IEC 721 EN 60721
Housing class 7M2	DIN IEC 721 EN 60721	DIN IEC 721 EN 60721
Temperature		
• Operation	-10 °C – 55 °C	-10 °C – 55 °C
• Transport	-40 °C – 75 °C	-40 °C – 75 °C
• Storage < 1 month	-20 °C – 60 °C	-20 °C – 60 °C
• Storage > 1 month	-20 °C – 45 °C	-20 °C – 45 °C

Dimensions	Pocket LOOX T810	Pocket LOOX T830
Height/width/depth	126.6 mm x 64.6 mm x 21.6 mm	126.6 mm x 64.6 mm x 21.6 mm
Weight	195 g +/- 10 g	195 g +/- 10 g

Battery (Li-Ion)

Rated capacity	1530 mAh
Charging time (when not in operation)	Max. 4 hours
Operating time	<ul style="list-style-type: none"> • Up to 4 hours GSM talk time • Up to 150 hours standby

Mains adapter

Electrical data	
Primary:	
• Rated voltage:	100 – 240 V
• Rated frequency:	50 – 60 Hz
Secondary:	
• Rated voltage:	5 V +/- 5 %
• Max. rated current:	1.0 A

Manufacturer's notes

Environmental protection

Fujitsu Siemens Computers has defined standards for environmentally friendly product design in a guideline that is applicable throughout the company. Ecological product requirements are continuously implemented by the binding application of these internal guidelines. The main points are:

- repair friendliness and long life due to modular design
- low noise emissions
- low energy consumption
- minimisation of material diversity
- ecological criteria for plastics
- avoidance of materials harmful to the environment
- recyclability

More details on the subject of environmental protection are available on the Internet at: ["www.fujitsu-siemens.de/umwelt"](http://www.fujitsu-siemens.de/umwelt) or ["www.fujitsu-siemens.com/rl/aboutus/envman/index.html"](http://www.fujitsu-siemens.com/rl/aboutus/envman/index.html).

Disposal and recycling

You will find further information about country-specific recycling and disposal options on the Internet at ["www.fujitsu-siemens.com/recycling"](http://www.fujitsu-siemens.com/recycling) or on the Microsoft Getting Started CD.

CE marking



Products bearing the CE marking comply with the R&TTE Directive (1999/5/EC), EMC Directive (89/336/EEC), and the Low Voltage Directive (73/23/EEC) issued by the Commission of the European Community.

CE compliance of this device is valid only if powered by a CE-marked AC Adapter provided by Fujitsu Siemens Computers. Compliance with these directives implies conformity with the following European Norms (the equivalent international standards and regulations are given in brackets):

- EN 55022 (CISPR 22) – Electromagnetic Interference
- EN 55024 (IEC 61000-4-2, 3, 4, 5, 6, 8, 11) – Electromagnetic Immunity
- EN 61000-3-2 (IEC 61000-3-2) – Power Line Harmonics
- EN 61000-3-3 (IEC 61000-3-3) – Power Line Flicker
- EN 60950 (IEC 60950) – Product Safety
- ETS 300 328-2 – Technical requirements for 2.4 GHz radio equipment
- EN 301 489-1, -17 – General EMC requirements for radio equipment

The IEEE 802.11b wireless LAN and Bluetooth functionality of this product can be used in the following EU countries, EU candidate countries and EFTA countries: Belgium, Denmark, Germany, Estonia, Finland, France, Greece, Great Britain, Ireland, Iceland, Italy, Liechtenstein, Latvia, Lithuania, Luxemburg, Malta, Netherlands, Norway, Austria, Poland, Portugal, Sweden, Switzerland, Slovakia, Slovenia, Spain, Czech Republic, Hungary and Cyprus.



The user is responsible for any radio interference caused when operating the device.

If the wireless LAN of this product is operated in accordance with IEEE 802.11b, only a limited band is available in France (Channels 10, 11, 12, and 13 only). According to the Autorité de régulation des télécommunications (ART), special regulations apply to hotspots on which other channels are also allowed. Please check with ART ("<http://www.art-telecom.fr>") about local regulations and licensing.

Information on exposure/specific absorption rate (SAR)

This device meets the EU requirements (1999/519/EU) on the protection of public health against the effects of exposure to electromagnetic fields.

The limits are part of extensive recommendations for the protection of the general public. These recommendations have been developed and checked by independent scientific organisations through regular and thorough evaluations of scientific studies. To guarantee the safety of all persons, regardless of age and health, the limits include a significant safety buffer.

Before radio devices can be put into use, their compliance with European laws or limits must be confirmed; only then may the CE symbol be applied.

The unit of measurement for the European Council's recommended limit for mobile telephones is the "Specific Absorption Rate" (SAR). This SAR limit is 2.0 W/kg, averaged over 10g of body tissue. It meets the requirements of the International Commission on Non-Ionizing Radiation Protection (ICNIRP) and was included in the European Standard EN 50360 for mobile radio devices. The SAR regulation for mobile telephones is in line with European Standard EN 50361. The maximum SAR value is calculated at the highest output level in all frequency bands of the mobile telephone. During use, the actual SAR level is usually much lower than the maximum value, because the mobile telephone works at different output levels. It only transmits with as much output as is required to reach the network. In general the following applies: the closer you are to a base station, the lower the transmission output of your mobile telephone.

The highest SAR values for this device, measured in accordance with the standard, are:

	Pocket LOOX T830	Pocket LOOX T810
When used next to ear:	0.188 W/kg (PCS Head)	0.111 W/kg (PCS Head)
When worn on body:	1.01 W/kg (PCS Body)/ 0.029 W/kg (WLAN Body)	0.91 W/kg (PCS Body)/ 0.042 W/kg (WLAN Body)

The SAR value for this device is also available on the Internet by searching for "QQXUPX001" at "www.fcc.gov/oet/fccid". Even if the SAR value differs depending on the device and the position used, all Fujitsu Siemens Computers devices comply with the legal requirements.

FCC Regulations

This device complies with part 15 of the FCC Rules. Operation is subject to the following two conditions: (1) This device may not cause harmful interference, and (2) this device must accept any interference received, including interference that may cause undesired operation.

This device has been tested and found to comply with the limits for a Class B digital device, pursuant to Part 15 of the FCC Rules. These limits are designed to provide reasonable protection against harmful interference in a residential installation. This equipment generates, uses and can radiate radio frequency energy and, if not installed and used in accordance with the instructions, may cause harmful interference to radio communications. However, there is no guarantee that interference will not occur in a particular installation. If this equipment does cause harmful interference to radio or television reception, which can be determined by turning the equipment off and on, the user is encouraged to try to correct the interference by one or more of the following measures:

- Reorient or relocate the receiving antenna.
- Increase the separation between the equipment and receiver.
- Connect the equipment into an outlet on a circuit different from that to which the receiver is connected.
- Consult the dealer or an experienced radio/TV technician for help.

Changes or modifications not expressly approved by the party responsible for compliance could void the user's authority to operate the equipment.

This device complies with FCC radiation exposure limits set forth for an uncontrolled environment. In order to avoid the possibility of exceeding the FCC radio frequency exposure limits, human proximity to the antenna shall not be less than 20 cm (8 inches) during normal operation.

FCC Warning Statement for WLAN product

This device complies with part 15 of the FCC Rules. Operation is subject to the following two conditions: (1) This device may not cause harmful interference, and (2) this device must accept any interference received, including interference that may cause undesired operation.

This device has been tested and found to comply with the limits for a Class B digital device, pursuant to Part 15 of the FCC Rules. These limits are designed to provide reasonable protection against harmful interference in a residential installation. This equipment generates, uses and can radiate radio frequency energy and, if not installed and used in accordance with the instructions, may cause harmful interference to radio communications. However, there is no guarantee that interference will not occur in a particular installation. If this equipment does cause harmful interference to radio or television reception, which can be determined by turning the equipment off and on, the user is encouraged to try to correct the interference by one or more of the following measures:

- Reorient or relocate the receiving antenna.
- Increase the separation between the equipment and receiver.
- Connect the equipment into an outlet on a circuit different from that to which the receiver is connected.
- Consult the dealer or an experienced radio/TV technician for help.

Changes or modifications not expressly approved by the party responsible for compliance could void the user's authority to operate the equipment.

This device complies with FCC radiation exposure limits set forth for an uncontrolled environment. In order to avoid the possibility of exceeding the FCC radio frequency exposure limits, human proximity to the antenna shall not be less than 20 cm (8 inches) during normal operation.

RF Exposure Information (SAR)

This device meets the government's requirements for exposure to radio waves. This device is designed and manufactured not to exceed the emission limits for exposure to radio frequency (RF) energy set by the Federal Communications Commission of the U.S. Government.

The exposure standard for wireless devices employs a unit of measurement known as the Specific Absorption Rate, or SAR. The SAR limit set by the FCC is 1.6 W/kg. *Tests for SAR are conducted using standard operating positions accepted by the FCC with the device transmitting at its highest certified power level in all tested frequency bands. Although the SAR is determined at the highest certified power level, the actual SAR level of the device while operating can be well below the maximum value. This is because the device is designed to operate at multiple power levels so as to use only the power required to reach the network. In general, the closer you are to a wireless base station antenna, the lower the power output.

The highest SAR value for the device as reported to the FCC when tested for use at the ear is 0.237 W/kg (PCS Head) and 0.033 W/kg (WLAN Head) for model T830, and 0.111 W/kg (PCS Head) and 0.025 W/kg (WLAN Head) for model T810, and when worn on the body, as described in this user guide, is 1.01 W/kg (PCS Body), and 0.029 W/kg (WLAN Body) for model T830, and 0.91 W/kg (PCS Body), and 0.042 W/kg (WLAN Body) for model T810. (Body-worn measurements differ among device models, depending upon available enhancements and FCC requirements.)

While there may be differences between the SAR levels of various devices and at various positions, they all meet the government requirement.

The FCC has granted an Equipment Authorization for this device with all reported SAR levels evaluated as in compliance with the FCC RF exposure guidelines. SAR information on this device is on file with the FCC and can be found under the Display Grant section of "<http://www.fcc.gov/oet/fccid>" after searching on FCC ID: QXXUPX001.

For body worn operation, this device has been tested and meets the FCC RF exposure guidelines for use with an accessory that contains no metal and the positions the handset a minimum of 1.5 cm from the body. Use of other enhancements may not ensure compliance with FCC RF exposure guidelines. If you do not use a body-worn accessory and are not holding the device at the ear, position the handset a minimum of 1.5 cm from your body when the device is switched on.

Index

- 2 megapixel autofocus camera 4
- 3-way scroll button 4
 - using 10

A

- Accessories 16
- ActiveSync
 - data synchronisation 23
- Alarms
 - setting 51
- Answer button 4
- Application button
 - calendar button 4
 - Camera 4
 - Mail Received 4
 - SpeedMenu 4
 - switching on 42
- Application buttons
 - using 12

B

- Background image
 - setting 51
- Backlight 72
 - configuring 73
- Battery
 - Capacity 3
 - charging 46
 - charging via a USB port 48
 - charging via mains adapter 47
 - charging via the cradle 48
 - discharges 78
 - installing 17–18
 - storing 3
 - technical data 81
- Bluetooth 71
 - activating 70
 - indicator 5
- Bright display 76

C

- Calibrating the screen 19
- Call
 - ending 29
 - holding 32
- Call Forwarding
 - setting up 38
- Calls: making 28
- Camera

- recording videos 63
- Settings 64
- taking pictures 62
 - using 62
- Cleaning 45
- Cold start 44
- Complete Off 42
- Conference call 32
- Configuring
 - Phone settings 36
- Configuring device settings 51
- CONNECTMOBILITY-E2C 20
 - starting 20
- Contacts 35
- Controls 4
- Creating ActiveSync partnership 23

D

- Dark display 76
- Data
 - technical 80
- Data synchronisation
 - via cradle 26
- Data synchronisation via ActiveSync 23
- Data transmission
 - Bluetooth 71
 - Wireless LAN 75
- Data transmission: Wireless LAN 70
- Date
 - setting 51
- Date is incorrect 76
- Description of buttons 7
- Device behaviour with e-mail push 73
- Device lock 7, 68
- Directory 35
- Display 4
 - cleaning 45
 - remains dark 76
- Display is difficult to read 76
- Display, difficult to read 76

E

- E-mail
 - configuring 56
 - creating 56–57
 - IMAP4 56
 - POP3 56
 - sending 57
 - SMTP 56
 - VPN corporate network 57

E-mail pull 58
E-mail push 59
 device behaviour 73
Emergency call 29
End button 4
 does not respond 78
 switching off 42
 switching on 42
Energy saving functions 72
Exchange Server
 configuring 22
 data synchronisation 22
 synchronising data 22
Expansion card 49
 inserting 49
 removing 50

F

Factory default settings 44
Fast access to programs 52
First start-up 19
FN mode 7
FSC GPSLocator 61
FSC KeyLock 68
FSC MobileZip 66
FSC SecureLock 69
FSC SpeedMenu 52

G

Getting started 17
GPS 61
 indicator 5
GSM port 4

H

Hands-free function 31
Hardware, overview 4
Hold
 call 32
Hotline/help desk 79

I

IMEI number 79
Inbox 53
 E-mail 53
 MMS 53
 SMS 53
Incoming call 29
Incorrect date/time 76
Indicator
 battery charge level 5

Bluetooth 5
GPS 5
 message 5
Information
 cleaning 45
Installation, new software 76
Installing ActiveSync 23
Internet
 CONNECTMOBILITY-E2C 20
 using 60
Internet Explorer 60
Intranet
 CONNECTMOBILITY-E2C 20

J

Java applications
 viewing 65
JBlend
 Java 65

K

Keyboard 7
Keyboard backlight: configuring 73

M

Mains adapter
 connecting 19
 technical data 81
 with mains adapter cable to Pocket PC 48
Menu
 customising 52
Messages
 creating 53
Microphone 4
Mini USB port 4
Missed calls
 displaying 29
MMS
 configuring 54
 sending 54
Modes
 profiles 40
Muting
 Pphone 31

N

Navigation key 4
 using 10
Network
 selecting 37
No sound 78

- Notes
 - Safety 3
- O**
- On-screen keyboard
 - using 14
- Online buttons for telephony
 - using 9
- Online help
 - using 27
- operating elements 7
- Operation, basic 20
- Optimising battery life 48
- Optimising energy management 72
- Overview
 - Hardware 4
 - software 15
- P**
- Password protection on Pocket PC 67
- PDF files
 - viewing 65
- PDF Viewer 65
- Pen
 - using 9
- Phone
 - muting 31
 - Settings 36
- Phone settings
 - configuring 36
- PIN 36
 - entering 20
- Pocket -PC
 - operating 39
- Pocket PC
 - cleaning 45
 - connecting with computer 24
 - does not work 77
 - switching off 41
 - switching on 19, 41
 - transporting 45
 - Use while driving 45
- Pocket PC:
 - use during a flight 45
- Pocket PC: connecting with other devices 70
- Pocket PC: networking 70
- Pocket-PC
 - does not start 77
 - resetting 43
- Pocket-PC: switches off automatically 77
- Poor GPS reception 78
- Ports 4
- Power indicator 4–5
- Preparation for use
 - basic operation 20
 - connecting the mains adapter 19
 - first start-up 19
 - screen 19
 - Today screen 20
- Preparing for use
 - inserting the battery 18
- Profiles 40
 - configuring 41
 - selecting 40
- Programs
 - ClearVue PDF 65
 - Windows Media Player 65
- Programs: FSC MobileZip 66
- R**
- Radio components
 - activating 70
- Radio indicator 4–5
- Resetting 43
- Restoring 44
- S**
- Safety information 3
- Screen
 - using 9
- SD slot 4
- Security 67
- Selecting the phone network 37
- Sending E-mail
 - via ActiveSync 57
- Silent mode 8, 40
- SIM card
 - blocking 36
 - installing 17
- SIM card manager 35
- SIM contacts 35
 - managing 35
- SIM Lock 36
- SIM security 36
- SMS
 - creating 54
- SMS Service Centre
 - setting up 38
- SMS Service Centre number
 - setting up 38
- Soft reset
 - carrying out 43
- Softkey buttons
 - using 12

- Software
 - new installation 76
 - overview 15
 - Sound
 - switching off 74
 - Speed dialling 30
 - Standby mode 42
 - Status
 - battery charge level 5
 - message 5
 - Status indicators 4
 - Storage, battery 3
 - Stylus
 - taking out 19
 - Summer time 76
 - Switch-off time 42
 - Switching off the Pocket PC 42
 - Switching on 42
 - Switching on the Pocket PC 42
- T**
- Technical data 80
 - Battery 81
 - mains adapter 81
 - Pocket PC 80
 - Telephone
 - using 28
 - Telephone functions 28
 - Time
 - incorrect 76
 - setting 51
 - Time is not correct 76
 - Tips 76
 - Today screen 20
 - Tones
 - setting 51
- Transport 45
 - Troubleshooting 76
- U**
- USB data transfer 51
 - USB Host
 - using Pocket PC as a USB Host 51
 - Using the cradle 25
- V**
- VGA camera 4
 - Video phone calls 33
 - Visual indicators
 - profiles 40
 - Voice Commander 30
 - Voice dialling 30
 - Voice notes 4
 - Voicemail
 - setting up 37
 - Volume
 - profiles 40
 - Volume, minimal 78
- W**
- Warm restart 43
 - Windows Media Player 65
 - Winter time 76
 - Wireless data transmission 70–71, 75
 - Wireless LAN 70, 75
 - activating 70
 - Wireless Manager 75
 - WLAN 70, 75
 - activating 70